



**COMMON TRAINING  
PROFICIENCY LEVEL FOUR  
INSTRUCTIONAL GUIDE**



**SECTION 1**

**EO M404.01 – PARTICIPATE IN THE CADET FITNESS ASSESSMENT**

---

Total Time:

60 min

---

**PREPARATION**

---

**PRE-LESSON INSTRUCTIONS**

Resources needed for the delivery of this lesson are listed in the lesson specification located in A-CR-CCP-804/PG-001, *Proficiency Level Four Qualification Standard and Plan*, Chapter 4. Specific uses for said resources are identified throughout the instructional guide within the TP for which they are required.

Review the lesson content and become familiar with the material prior to delivering the lesson. Additional information on the Cadet Fitness Assessment can be found in CATO 14-18, *Cadet Fitness Assessment and Incentive Program*.

Photocopy the Cadet Fitness Assessment Scoresheet located at Attachment B and the 20-m Shuttle Run Test Individual Scoresheet B located at Attachment C for each cadet.

The cadets will complete the Cadet Fitness Assessment in pairs. The 20-m Shuttle Run Test will be conducted first, with the remaining stations run as a circuit.

**PRE-LESSON ASSIGNMENT**

Nil.

**APPROACH**

A practical activity was chosen for this lesson as it allows the cadets to participate in the Cadet Fitness Assessment in a safe and controlled environment.

---

**INTRODUCTION**

---

**REVIEW**

Review how to conduct the components of the Cadet Fitness Assessment from EO M304.01 (Describe the Components of Physical Fitness).

**OBJECTIVES**

By the end of this lesson the cadet shall have participated in the Cadet Fitness Assessment.

## **IMPORTANCE**

It is important for the cadets to participate in the Cadet Fitness Assessment to determine their personal fitness level, and when conducted multiple times over the course of the year, it allows progress to be tracked. Determining personal fitness level will also allow the cadets to create personal goals and will assist with updating a Personal Activity Plan.

**Teaching Point 1****Conduct a warm-up session composed of light cardiovascular exercises.**

Time: 5 min

Method: Practical Activity



The following information will be explained to the cadets during the warm-up session.

**PURPOSE OF A WARM-UP**

A warm-up session is composed of stretches and light cardiovascular exercises designed to:

- stretch the muscles;
- gradually increase respiratory action and heart rate;
- expand the muscles' capillaries to accommodate the increase in blood circulation which occurs during physical activity; and
- raise the muscle temperature to facilitate reactions in muscle tissue.

**GUIDELINES FOR STRETCHING**

The following guidelines should be followed while stretching to prepare for physical activity and to help prevent injury:

- Stretch all major muscle groups, including the back, chest, legs, and shoulders.
- Never bounce while stretching.
- Hold each stretch for 10–30 seconds to let the muscles release fully.
- Repeat each stretch two to three times.
- When holding a stretch, support the limb at the joint.
- Static stretching, which is stretching a muscle and holding it in position without discomfort for 10–30 seconds, is considered the safest method.
- Stretching helps to relax the muscles and improve flexibility, which is the range of motion in the joints.
- As a guide, allow 10 minutes to warm up for every hour of physical activity.



The stretches chosen should focus on the areas of the body that will be used the most during the physical activity.

---

## ACTIVITY

### OBJECTIVE

The objective of this warm-up activity is to stretch the muscles and perform light cardiovascular exercises to prepare the body for physical activity and to help prevent injuries.

### RESOURCES

Nil.

### ACTIVITY LAYOUT

Nil.

### ACTIVITY INSTRUCTIONS

1. Arrange the cadets in either a warm-up circle or in rows (as illustrated in Figures 1 and 2).

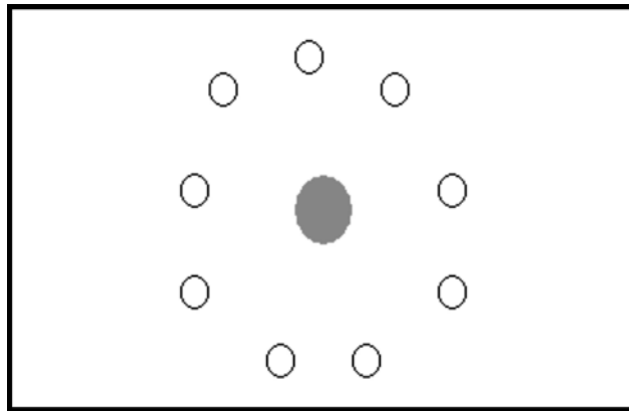

Figure 1 Instructor in the Centre of a Warm-Up Circle

*Note.* Created by Director Cadets 3, 2006, Ottawa, ON: Department of National Defence.

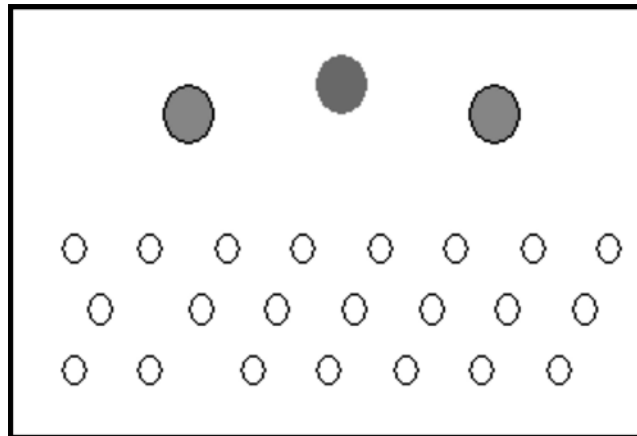

Figure 2 Instructor at the Front with Two Assistant Instructors

*Note.* Created by Director Cadets 3, 2006, Ottawa, ON: Department of National Defence.

2. Demonstrate before having the cadets attempt each stretch / light cardiovascular exercise.

3. Assistant instructors may help demonstrate the exercises and ensure the cadets are performing them correctly.
4. Have cadets perform each stretch / light cardiovascular exercise.



Light cardiovascular exercises should be done to warm up the muscles prior to stretching to avoid injury to or tearing of the muscles. For example, running on the spot for 30 seconds or performing jumping jacks should be performed prior to conducting the stretches located at Attachment A.

## SAFETY

- Ensure there are at least two arm lengths between the cadets so they can move freely.
- Ensure the cadets perform the stretches and light cardiovascular exercises in a safe manner, following the guidelines for stretching listed in this TP.

---

## CONFIRMATION OF TEACHING POINT 1

The cadets' participation in the warm-up session will serve as the confirmation of this TP.

---

## Teaching Point 2

**Supervise while the cadets perform and score the Cadet Fitness Assessment.**

Time: 15 min

Method: Practical Activity



The cadets will participate in the Cadet Fitness Assessment in pairs.

The 20-m Shuttle Run Test will be conducted before the other assessments. A summary of how to conduct the 20-m Shuttle Run Test is located at Attachment C.

The remaining assessments will be conducted as a circuit (summaries of how to conduct the assessments are located at the respective attachments) and are as follows:

1. the curl-up, located at Attachment D,
2. the push-up, located at Attachment E, and
3. choose two of the following:
  - a. the trunk lift, located at Attachment F,
  - b. the shoulder stretch, located at Attachment G, and
  - c. the back-saver sit and reach, located at Attachment H.

---

## ACTIVITY

### OBJECTIVE

The objective of this activity is to have the cadets perform and score the 20-m Shuttle Run Test.

## RESOURCES

- *Leger 20-m Shuttle Run Test CD*,
- CD player,
- Pylons, and
- Photocopies of the *20-m Shuttle Run Test Individual Scoresheet B* located at Attachment C.

## ACTIVITY LAYOUT

Nil.

## ACTIVITY INSTRUCTIONS

1. Divide the cadets into pairs.
2. Distribute the *20-m Shuttle Run Test Individual Scoresheet B* and pens / pencils to one cadet from each pair.
3. Have the cadets with the scoresheet print their partner's name on the scoresheet and sit behind the starting line ready to record results.
4. Have the cadets who are running the 20-m Shuttle Run Test line up in their respective lanes at the starting line and wait for instructions from the CD.
5. Play the CD. The scorekeeper will record the number of laps that are successfully completed on the scoresheet. The supervisors at each line will inform the scorekeeper when a cadet does not cross the line before the beep. The 20-m Shuttle Run Test is complete when all the cadets have not reached the line before the beep for the second time.
6. Once completed, have the cadets who ran the 20-m Shuttle Run Test become the scorekeepers and the scorekeepers become the runners.
7. Repeat Steps 2–6.

## SAFETY

- Ensure a designated first-aider and first aid kit are available.
- Ensure water is available for the cadets after they complete the 20-m Shuttle Run Test.



Distribute the Cadet Fitness Assessment Scoresheet located at Attachment B to each cadet prior to starting the circuit.

---

## ACTIVITY

### OBJECTIVE

The objective of this activity is to have the cadets perform and score the curl-up.

**RESOURCES**

- CD player,
- Gym mats, and
- Curl-up measuring strip.

**ACTIVITY LAYOUT**

Nil.

**ACTIVITY INSTRUCTIONS**

1. Have one cadet from each pair:
  - a. lay on their back with head down;
  - b. bend their knees at an angle of approximately 140 degrees;
  - c. place their feet flat and legs slightly apart; and
  - d. rest their palms on the mat with their arms straight, parallel to their trunk, and fingers stretched out.
2. The scorekeeper will place the measuring strip on the mat under the cadet's knees so the fingertips are resting on the nearest edge of the measuring strip.
3. The cadet on the mat will curl up, ensuring their fingers reach the other side of the measuring strip, repeatedly at a cadence of one curl every three seconds until a second form correction (the first form correction does not count) is made, they can no longer continue, or they have completed 75 curl ups.
4. The scorekeeper will count how many times the cadet can curl up (which is the curl-up score).
5. Have the cadets switch positions and repeat Steps 1–4.

**SAFETY**

Ensure that the curl-up is conducted using the proper position / form.

---

**ACTIVITY****OBJECTIVE**

The objective of this activity is to have the cadets perform and score the push-up.

**RESOURCES**

Nil.

**ACTIVITY LAYOUT**

Nil.

**ACTIVITY INSTRUCTIONS**

1. Have one cadet from each pair:
  - a. lay face down;
  - b. place their hands under or slightly wider than their shoulders, with fingers stretched out;

- c. straighten their legs with feet slightly apart; and
  - d. tuck their toes under the shins.
2. Have the cadet push up with their arms until they are straight, keeping the legs and back aligned.
3. Have the cadet lower their body using their arms until the elbows bend at a 90-degree angle and the upper arms are parallel to the floor.
4. Have the cadet repeat steps two and three repeatedly at a cadence of one push-up every three seconds until a second form correction (the first form correction does not count) is made, or they can no longer continue.
5. The scorekeeper will count how many times the cadet can complete a push-up (which is the push-up score).
6. Have the cadets switch positions and repeat Steps 1–5.

### **SAFETY**

Ensure that the push-up is conducted using the proper position / form.

---

## **ACTIVITY**

### **OBJECTIVE**

The objective of this activity is to have the cadets perform and score the trunk lift.

### **RESOURCES**

- Gym mats, and
- Trunk lift measuring device.

### **ACTIVITY LAYOUT**

Nil.

### **ACTIVITY INSTRUCTIONS**

1. Have one cadet from each pair:
  - a. lay face down on the mat;
  - b. point their toes towards the end of the mat; and
  - c. place their hands under thighs.
2. Place a marker (a coin will suffice) on the mat aligned with the cadet's eyes.
3. Have the cadet lift their upper body off the floor in a slow and controlled manner, to a maximum height of 30 cm (12 inches). Ensure their head is aligned straight with the spine.
4. Have the cadet hold this position until the height can be measured.
5. The scorekeeper will measure the distance, in inches between the mat and the cadet's chin to determine the trunk lift score. The score will be a maximum of 12 inches to prevent hyperextension.
6. Have the cadets switch positions and repeat Steps 1–5.



**SAFETY**

- The ruler should be placed at least one inch from the cadet's chin and not directly under the chin.
  - The cadets shall not bounce or hyperextend their backs while performing the trunk lift.
- 

**ACTIVITY****OBJECTIVE**

The objective of this activity is to have the cadets perform and score the shoulder stretch.

**RESOURCES**

Nil.

**ACTIVITY LAYOUT**

Nil.

**ACTIVITY INSTRUCTIONS**

1. Have one cadet from each pair test their right shoulder by:
  - a. reaching with the right hand over the right shoulder and down the back; and
  - b. reaching with the left hand behind the back to touch the right hand.
2. The scorekeeper will observe if the hands are touching to determine the right shoulder stretch score (a yes or no).
3. Have the cadet test their left shoulder by:
  - a. reaching with the left hand over the left shoulder and down the back; and
  - b. reaching with the right hand behind the back to touch the left hand.
4. The scorekeeper will observe if the hands are touching to determine the left shoulder stretch score.
5. Have the cadets switch positions and repeat Steps 1–4.

**SAFETY**

Nil.

---

**ACTIVITY****OBJECTIVE**

The objective of this activity is to have the cadets perform and score the back-saver sit and reach.

**RESOURCES**

Back-saver sit and reach test apparatus (instructions located at Attachment I).

**ACTIVITY LAYOUT**

Nil.

## ACTIVITY INSTRUCTIONS

1. Have one cadet from each pair remove their shoes.
2. Have the cadet:
  - a. sit in front of the test apparatus;
  - b. extend one leg fully with the foot flat against the face of the box;
  - c. bend the knee of the other leg with the sole of the foot flat on the floor placed next to the knee of the straight leg;
  - d. ensure that there is a 5–8 cm (2–3 inch) space between the knee on the straight leg, and the foot of the bent leg; and
  - e. extend their arms forward with the hands placed on top of one another placing the finger tips just in front of the tip of the ruler.
3. Have the cadet reach forward with both hands along the scale four times, holding the position on the fourth reach for at least one second.
4. The scorekeeper will measure the distance, in inches that the cadet reached. This measurement will be the score for one leg, to a maximum of 12 inches to prevent hyperextension.
5. Have the cadet repeat steps one to three for the other leg.
6. Have the cadets switch positions and repeat Steps 1–4.

## SAFETY

Nil.

---

## CONFIRMATION OF TEACHING POINT 2

The cadets' participation in the Cadet Fitness Assessment will serve as the confirmation of this TP.

---

### Teaching Point 3

**Conduct a cool-down session composed of light cardiovascular exercises.**

Time: 5 min

Method: Practical Activity



The following information will be explained to the cadets during the cool-down session.

## PURPOSE OF A COOL-DOWN

A cool-down is composed of stretches and light cardiovascular exercises designed to:

- allow the body time to slowly recover from physical activity and to help prevent injury;
- prepare the respiratory system to return to its normal state; and
- stretch the muscles to help relax and restore them to their resting length.



The stretches chosen should focus on the areas of the body that were used the most during the sports activity.

---

## ACTIVITY

### OBJECTIVE

The objective of the cool-down is to stretch the muscles and perform light cardiovascular exercises that allow the body time to recover from physical activity and to prevent injury.

### RESOURCES

Nil.

### ACTIVITY LAYOUT

Nil.

### ACTIVITY INSTRUCTIONS

1. Arrange the cadets in either a warm-up circle or in rows (as illustrated in Figures 1 and 2 of TP 1).
2. Demonstrate before having the cadets attempt each stretch / light cardiovascular exercise.
3. Assistant instructors may help demonstrate the movements and ensure the cadets are performing them correctly.
4. Have cadets perform each stretch / light cardiovascular exercise.

### SAFETY

- Ensure there are at least two arm lengths between the cadets so they can move freely.
- Ensure the cadets perform the stretches and light cardiovascular exercises in a safe manner, following the guidelines for stretching listed in TP 1.

---

### CONFIRMATION OF TEACHING POINT 3

The cadets' participation in the cool-down session will serve as the confirmation of this TP.

---

### END OF LESSON CONFIRMATION

The cadets' participation in the Cadet Fitness Assessment will serve as the confirmation of this lesson.

---

## CONCLUSION

---

### HOMework / READING / PRACTICE

Nil.

## **METHOD OF EVALUATION**

Nil.

## **CLOSING STATEMENT**

The Cadet Fitness Assessment determines personal fitness level and is an excellent tool for tracking progress in personal fitness.

## **INSTRUCTOR NOTES / REMARKS**

The Cadet Fitness Assessment is an individual assessment used to set personal fitness goals. Results from this assessment shall not be used for competition or classification among cadets.

The Cadet Fitness Assessment shall be set up prior to conducting this EO.

This EO shall be conducted at the start and the end of the training year.

---

## **REFERENCES**

---

A0-204 CATO 14-18 D Cdts. (2010). *Cadet Fitness Assessment and Incentive Program*. Ottawa, ON: Department of National Defence.

C0-095 ISBN 0-7360-5962-8 The Cooper Institute. (n.d.). *Fitnessgram / activitygram test administration kit: Fitnessgram 8.0 stand-alone test kit*. Windsor, ON: Human Kinetics.

C0-167 ISBN 0-7360-5866-4 Meredith, M., & Welk, G. (Eds.). (2005). *Fitnessgram / activitygram: Test administration manual* (3rd ed.). Windsor, ON: Human Kinetics.

## SAMPLE STRETCHES

a. Neck:

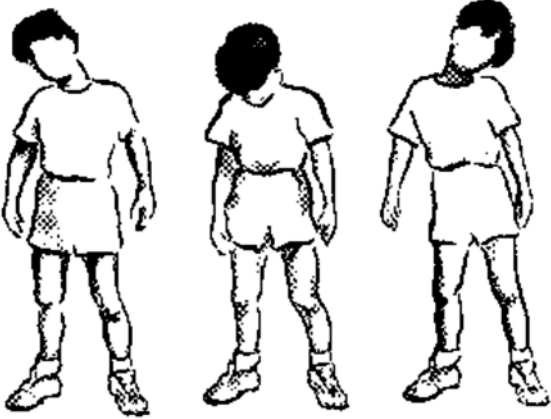
 <p>Figure A-1 Neck Stretch</p> <p><i>Note.</i> From <i>Moving on the Spot: A Collection of 5 Minute Stretch and Movement Sessions</i>, by B. Hanson, 1999, Toronto, ON: Toronto Public Health. Retrieved October 26, 2006, from <a href="http://www.lin.ca/resource/html/dn3.htm#1">http://www.lin.ca/resource/html/dn3.htm#1</a></p>	<p>Slowly roll your head across your chest from shoulder to shoulder. Do not roll your head backwards.</p>
---	--

b. Shoulders:



Figure A-2 Shoulder Push

*Note.* From *Moving on the Spot: A Collection of 5 minute Stretch and Movement Sessions*, by B. Hanson, 1999, Toronto, ON: Toronto Public Health. Retrieved October 26, 2006, from <http://www.lin.ca/resource/html/dn3.htm#1>

Stand and extend your arms behind you, interlocking your fingers. Push up and back with your shoulders.

Hold this position for a minimum of 10 seconds.



Figure A-3 Shoulder Shrug

*Note.* From *Moving on the Spot: A Collection of 5 minute Stretch and Movement Sessions*, by B. Hanson, 1999, Toronto, ON: Toronto Public Health. Retrieved October 26, 2006, from <http://www.lin.ca/resource/html/dn3.htm#1>

Stand and raise your shoulders as high as possible and then lower your shoulders, stretching your neck up.

Pull your shoulders back as far as possible and then round your shoulders forward by pushing your shoulders forward as far as possible.

Hold each position for a minimum of 10 seconds.



Figure A-4 Arm Circles

*Note.* From *Warm Ups*, by Martha Jefferson Hospital, Copyright 2001 by Martha Jefferson Hospital. Retrieved October 26, 2006, from <http://www.marthajefferson.org/warmup.php>

Hold your arms straight out, palms up. Make small circles with your arms, gradually increasing the size.

Reverse the direction of your circles.



Figure A-5 Shoulder Stretch

*Note.* From *Smart Start: A Flexible Way to Get Fit*. Retrieved October 26, 2006, from <http://www.in-motion.ca/walkingworkout/plan/flexibility/>

Either standing or sitting, take your right arm in your left hand and bring it across your chest, supporting the joint by holding it behind the elbow. Pull the elbow lightly towards your chest. You should feel the stretch in your right shoulder.

Hold this position for a minimum of 10 seconds and repeat on the opposite side.

c. Arms:



Figure A-6 Wrist Rotations

*Note.* From *Exercises*. Copyright 1998 by Impacto Protective Products Inc. Retrieved October 26, 2006, from <http://www.2protect.com/home.htm>

Rotate your hands in circular motions at the wrist.

Change direction and repeat on both sides.



Figure A-7 Triceps Stretch

*Note.* From *Smart Start: A Flexible Way to Get Fit*. Retrieved October 26, 2006, from <http://www.in-motion.ca/walkingworkout/plan/flexibility/>

Stand and bring your right arm over your head, bent at the elbow. Use your left hand to gently pull your arm down.

Hold this position for a minimum of 10 seconds and repeat on the opposite side.



Figure A-8 Forearm Stretch

*Note.* From *Exercise Programme for Squash, Tennis, Softball, Handball*. Retrieved October 26, 2006, from <http://www.physionline.co.za/conditions/article.asp?id=49>

In a kneeling position, place your hands on the floor in front of you with your fingers pointing toward your knees, and your thumbs pointing out. Keeping your hands flat on the floor, lean back.

Hold this position for a minimum of 10 seconds.

d. Chest and Abdominals:



Figure A-9 Chest Stretch

*Note.* From *Smart Start: A Flexible Way to Get Fit*. Retrieved October 26, 2006, from <http://www.in-motion.ca/walkingworkout/plan/flexibility/>

Stand facing a wall. With your right arm bent and your elbow at shoulder height, place your palm against the wall. Turn your body away from your right arm. You should feel the stretch on the front side of your armpit and across the front of you chest.

Hold this position for a minimum of 10 seconds and repeat on the opposite side.



Figure A-10 Side Stretch

*Note.* From *Moving on the Spot: A Collection of 5 minute Stretch and Movement Sessions*, by B. Hanson, 1999, Toronto, ON: Toronto Public Health. Retrieved October 26, 2006, from <http://www.lin.ca/resource/html/dn3.htm#1>

Stand with your left arm up over your head. Bend at the waist towards the right side of your body.

Hold this position for a minimum of 10 seconds and repeat on the opposite side.



e. Back:



Figure A-11 Lower Back Stretch

*Note.* From *Smart Start: A Flexible Way to Get Fit*. Retrieved October 26, 2006, from <http://www.in-motion.ca/walkingworkout/plan/flexibility/>

Lie on your back and bring your knees toward your chest. Grasp the back of your knees.

Hold this position for a minimum of 10 seconds.



Figure A-12 Upper Back Stretch

*Note.* From *Smart Start: A Flexible Way to Get Fit*. Retrieved October 26, 2006, from <http://www.in-motion.ca/walkingworkout/plan/flexibility/>

Extend your arms straight in front of you at shoulder height crossing one arm over the other. With the palms facing each other, intertwine your fingers and press out through your arms. Let your chin fall to your chest as you exhale. You should feel the stretch in the upper back.

Hold this position for a minimum of 10 seconds and repeat on the opposite side.

f. Legs:



Figure A-13 Hamstring Stretch

*Note. From Smart Start: A Flexible Way to Get Fit. Retrieved October 26, 2006, from <http://www.in-motion.ca/walkingworkout/plan/flexibility/>*

Lie flat on the floor with your knees bent and your back flat on the floor. Slowly raise and straighten one leg, grasping it behind your thigh with both hands.

Hold this position for a minimum of 10 seconds.



Figure A-14 Inner Thigh Stretch

*Note. From Smart Start: A Flexible Way to Get Fit. Retrieved October 26, 2006, from <http://www.in-motion.ca/walkingworkout/plan/flexibility/>*

Sit on the floor with your knees bent and the soles of your feet together. Grab your toes and pull yourself forward while keeping your back and neck straight.

Hold this position for a minimum of 10 seconds.

Grab your ankles and push your knees down toward the floor with your elbows.

Hold this position for a minimum of 10 seconds.



Figure A-15 Hip Flexor

*Note. From Smart Start: A Flexible Way to Get Fit. Retrieved October 26, 2006, from <http://www.in-motion.ca/walkingworkout/plan/flexibility/>*

Kneel on your right knee. Position your left foot in front of you, bending your knee and placing your left hand on that leg for stability. Keep your back straight and abdominal muscles tight. Lean forward, shifting more body weight onto your front leg. You should feel the stretch in the front of your hip and the thigh of the leg you are kneeling on. Cushion your kneecap with a folded towel if necessary.

Hold this position for a minimum of 10 seconds and repeat on the opposite side.

f. Legs Continued:



Figure A-16 Ankle Rotations

Note. From *Running Exercises*. Retrieved October 26, 2006, <http://www.physionline.co.za/conditions/article.asp?id=46>

From a sitting position, rotate your foot in a clockwise, and then a counter-clockwise, direction.

Switch and repeat on the opposite side.



Figure A-17 Calf Stretch

Note. From *Smart Start: A Flexible Way to Get Fit*. Retrieved October 26, 2006, from <http://www.in-motion.ca/walkingworkout/plan/flexibility/>

Stand three steps away from and facing a wall. Step in towards the wall with your right leg, bending your right knee and keeping your left leg straight. Extending your arms with your palms forward, reach out to the wall and let your body fall toward the wall. Keep your toes forward and your heels down. Lean your body into the wall with your left leg straight behind your body. You should feel the stretch in your left calf.

Hold this position for a minimum of 10 seconds and repeat on the opposite side.



Figure A-18 Quadriceps Stretch

Note. From *Smart Start: A Flexible Way to Get Fit*. Retrieved October 26, 2006, from <http://www.in-motion.ca/walkingworkout/plan/flexibility/>

Stand with your hand against a wall for balance. Lift your left foot off the ground, bending your knee as if you are trying to kick your bottom with your heel. Do not lean forward at the hips. Grab and hold your ankle with your left hand. You should feel the stretch in your left thigh.

Hold this position for a minimum of 10 seconds and repeat on the opposite side.

THIS PAGE INTENTIONALLY LEFT BLANK

## CADET FITNESS ASSESSMENT SCORESHEET

Name: \_\_\_\_\_

	Assessment 1	Assessment 2	Assessment 3
	<b>Date:</b>	<b>Date:</b>	<b>Date:</b>
	<b>Score</b>	<b>Score</b>	<b>Score</b>
<b>Cardiovascular</b>			
20-m Shuttle Run Test			
<b>Muscular Strength</b>			
Curl-up			
Push-up			
<b>Muscular Flexibility</b>			
Trunk Lift			
Shoulder Stretch	<b>Right:</b>	<b>Right:</b>	<b>Right:</b>
	<b>Left:</b>	<b>Left:</b>	<b>Left:</b>
Back-Saver Sit and Reach	<b>Right:</b>	<b>Right:</b>	<b>Right:</b>
	<b>Left:</b>	<b>Left:</b>	<b>Left:</b>

*Note.* Created by Director Cadets 3, 2007, Ottawa, ON: Department of National Defence.

THIS PAGE INTENTIONALLY LEFT BLANK

## 20-m Shuttle Run Test

### Objective:

The 20-m Shuttle Run Test is progressive, in that it begins with an easy pace and gradually becomes more challenging as time passes. The 20-m Shuttle Run Test is an individual assessment and is based on personal ability.

The 20-m Shuttle Run Test consists of running a distance of 20 m repeatedly, at a specified pace that increases each minute. Each cadet will be expected to run until they can no longer continue.

### Scoring:

The 20-m Shuttle Run Test will be scored using the *20-m Shuttle Run Test Individual Scoresheet B* at Annex C. Each circle on the scoresheet represents a lap. When the cadet completes a lap they receive a check mark. If they are unsuccessful they receive an X. The cadet has completed the 20-m Shuttle Run Test when they are unable to successfully complete a lap a second time.

### Equipment Required:

- CD player, and
- Pylons.

### Set-Up:

1. Set up two lines (pylons) a distance of 20 m apart.
2. Create 100- to 150-cm (40- to 60-inch) lanes depending on the number of participants, using pylons (as illustrated in Figure C-1).
3. Ensure that the CD player is close by and can be heard by all participants.

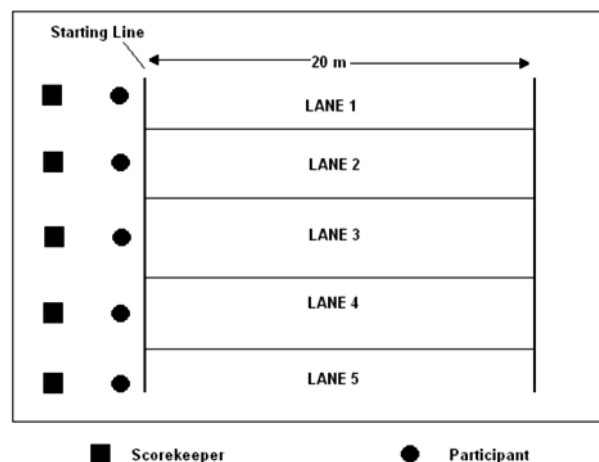

Figure C-1 20-m Shuttle Run Test Layout

Note. Created by Director Cadets 3, 2006, Ottawa, ON: Department of National Defence.

**Conducting the 20-m Shuttle Run Test:**

1. Divide the cadets into pairs.
2. Distribute the *20-m Shuttle Run Test Individual Scoresheet B* and pens / pencils to one cadet from each pair.
3. Have the cadets with the scoresheet print their partner's name on the scoresheet and sit behind the starting line ready to record results.
4. Have the cadets who are running the 20-m Shuttle Run Test line up in their respective lanes at the starting line and wait for instructions from the CD.
5. Play the CD. The scorekeeper will record the number of laps that are successfully completed on the scoresheet. The supervisors at each line will inform the scorekeeper when a cadet does not cross the line before the beep. The 20-m Shuttle Run Test is complete when all the cadets have not reached the line before the beep for the second time.
6. Once completed, have the cadets who ran the 20-m Shuttle Run Test become the scorekeepers and the scorekeepers become the runners.
7. Repeat Steps 2–6.



**FITNESSGRAM 20-m Shuttle Run Test Individual Score Sheet B**

Student Name \_\_\_\_\_ Class \_\_\_\_\_ Date \_\_\_\_\_

1	2	3	4	5	6	7	8	9
10	11	12	13	14	15	16	17	18
19	20	21	22	23	24	25	26	27
28	29	30	31	32	33	34	35	36
37	38	39	40	41	42	43	44	45
46	47	48	49	50	51	52	53	54

Figure C-2 Fitnessgram 20-m Shuttle Run Test Individual Scoresheet B

*Note.* From *Fitnessgram / Activitygram: Test Administration Manual* (3rd ed.) (p. 92), by The Cooper Institute, 2005, Windsor, ON: Human Kinetics. Copyright 2005 by The Cooper Institute.

THIS PAGE INTENTIONALLY LEFT BLANK

## Curl-Up

### Objective:

The curl-up with knees bent and feet unanchored was chosen because it is a safe method for assessing abdominal strength and endurance.

This assessment is conducted by curling up repeatedly at a pace of one curl-up every three seconds until a second form correction is made (the first form correction does not count), the person can no longer continue, or has completed 75 curl-ups.

### Scoring:

Scoring is based on the number of curl-ups that are completed; until a second form correction (the first form correction does not count) is made, the participant can no longer continue or the participant has completed 75 curl-ups.

### Equipment Required:

- *Fitnessgram 8.0 Stand-Alone Test Kit*,
- CD player,
- Gym mats, and
- Curl-up measuring strip.

### Set-Up:

1. Set up each curl-up station with a gym mat and a curl-up measuring strip.
2. Ensure that the CD player is close by and can be heard by all participants.

### Conducting the Curl-Up:

1. Have one cadet from each pair:
  - a. lay on their back with head down;
  - b. bend their knees at an angle of approximately 140 degrees;
  - c. place their feet flat and legs slightly apart; and
  - d. rest their palms on the mat with their arms straight, parallel to their trunk, and fingers stretched out (as illustrated in Figure D-1).

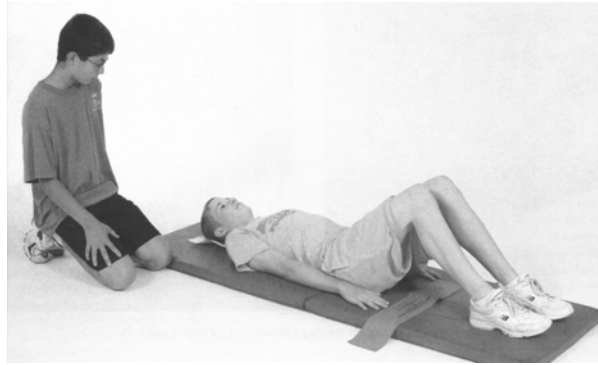

Figure D-1 Curl-Up Starting Position

*Note.* From *Fitnessgram / Activitygram: Test Administration Manual* (3rd ed.) (p. 43), by The Cooper Institute, 2005, Windsor, ON: Human Kinetics. Copyright 2005 by The Cooper Institute.

2. The cadet on the mat will curl up (as illustrated in Figure D-2), ensuring their fingers reach the other side of the measuring strip (as illustrated in Figure D-3), repeatedly at a cadence of one curl every three seconds until a second form correction (the first form correction does not count) is made, they can no longer continue or have completed 75 curl-ups.



Figure D-2 Curl-Up

*Note.* From *Fitnessgram / Activitygram: Test Administration Manual* (3rd ed.) (p. 43), by The Cooper Institute, 2005, Windsor, ON: Human Kinetics. Copyright 2005 by The Cooper Institute.

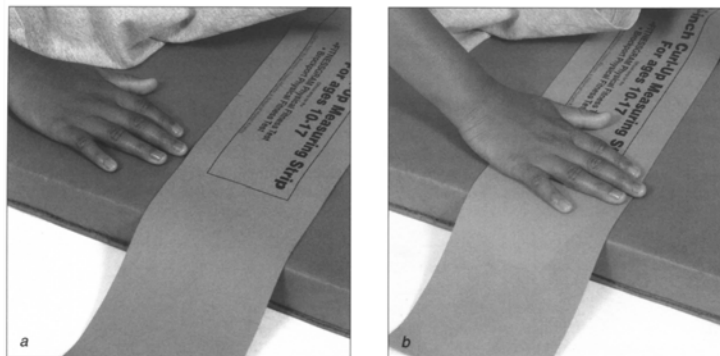

Figure D-3 Curl-Up Finger Position

*Note.* From *Fitnessgram / Activitygram: Test Administration Manual* (3rd ed.) (p. 44), by The Cooper Institute, 2005, Windsor, ON: Human Kinetics. Copyright 2005 by The Cooper Institute.

3. The scorekeeper will count how many times the cadet can curl up (which is the curl-up score).
4. Have the cadets switch positions and repeat Steps 1–4.

THIS PAGE INTENTIONALLY LEFT BLANK

## Push-Up

### Objective:

The push-up from an elbow angle of 90 degrees is a test of upper body strength and endurance.

This assessment is conducted by pushing up repeatedly at a pace of one push-up every three seconds until a second form correction is made (the first form correction does not count) or the person can no longer continue.

### Scoring:

Scoring is based on the number of push-ups that are completed, until a second form correction (the first form correction does not count) is made or the participant can no longer continue.

### Equipment Required:

- CD player.

### Set-Up:

1. Ensure that the push-up station is set up with enough space for the number of participants.
2. Ensure that the CD player is close by and can be heard by all.

### Conducting the Push-Up:

1. Have one cadet from each pair:
  - a. lay face down;
  - b. place their hands under or slightly wider than their shoulders, with fingers stretched out;
  - c. straighten their legs with feet slightly apart; and
  - d. tuck their toes under the shins.
2. Have the cadet push up with their arms until they are straight, keeping the legs and back aligned (as illustrated in Figure E-1).

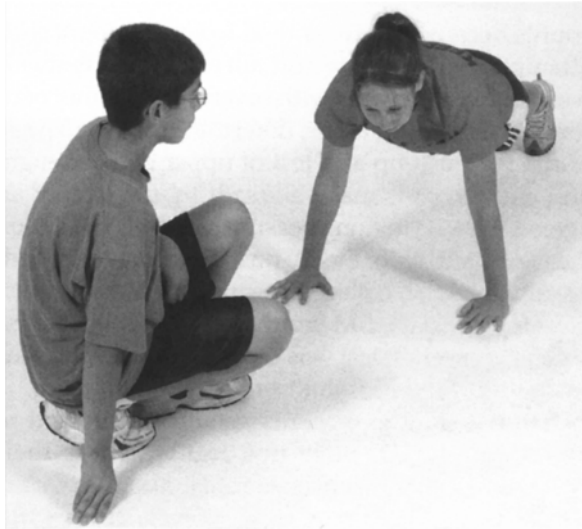

Figure E-1 Push-Up Starting Position

*Note.* From *Fitnessgram / Activitygram: Test Administration Manual* (3rd ed.) (p. 48), by The Cooper Institute, 2005, Windsor, ON: Human Kinetics. Copyright 2005 by The Cooper Institute.

3. Have the cadet lower their body using their arms until the elbows bend at a 90-degree angle and the upper arms are parallel to the floor (as illustrated in Figure E-2).



Figure E-2 Down Position of the Push-Up

*Note.* From *Fitnessgram / Activitygram: Test Administration Manual* (3rd ed.) (p. 48), by The Cooper Institute, 2005, Windsor, ON: Human Kinetics. Copyright 2005 by The Cooper Institute.

4. Have the cadet repeat steps two and three repeatedly at a cadence of one push-up every three seconds until a second form correction (the first form correction does not count) is made, or they can no longer continue.
5. The scorekeeper will count how many times the cadet can complete a push-up (which is the push-up score).
6. Have the cadets switch positions and repeat Steps 1–5.



## Push-Up

### Objective:

The push-up from an elbow angle of 90 degrees is a test of upper body strength and endurance.

This assessment is conducted by pushing up repeatedly at a pace of one push-up every three seconds until a second form correction is made (the first form correction does not count) or the person can no longer continue.

### Scoring:

Scoring is based on the number of push-ups that are completed, until a second form correction (the first form correction does not count) is made or the participant can no longer continue.

### Equipment Required:

- *FITNESSGRAM 20-m Shuttle Run Test* CD: Push-Up Cadence, and
- CD player.

### Set-Up:

1. Ensure that the push-up station is set up with enough space for the number of participants.
2. Ensure that the CD player is close by and can be heard by all.

### Conducting the Push-Up:

1. Have one cadet from each pair:
  - a. lay face down;
  - b. place their hands under or slightly wider than their shoulders, with fingers stretched out;
  - c. straighten their legs with feet slightly apart; and
  - d. tuck their toes under the shins.
2. Have the cadet push up with their arms until they are straight, keeping the legs and back aligned (as illustrated in Figure E-1).

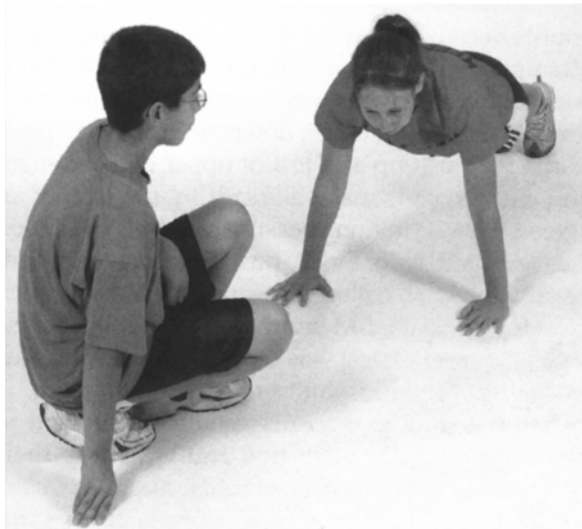

Figure E-1 Push-Up Starting Position

*Note.* From *Fitnessgram / Activitygram: Test Administration Manual* (3rd ed.) (p. 48), by The Cooper Institute, 2005, Windsor, ON: Human Kinetics. Copyright 2005 by The Cooper Institute.

3. Have the cadet lower their body using their arms until the elbows bend at a 90-degree angle and the upper arms are parallel to the floor (as illustrated in Figure E-2).



Figure E-2 Down Position of the Push-Up

*Note.* From *Fitnessgram / Activitygram: Test Administration Manual* (3rd ed.) (p. 48), by The Cooper Institute, 2005, Windsor, ON: Human Kinetics. Copyright 2005 by The Cooper Institute.

4. Have the cadet repeat Steps 2 and 3 repeatedly at a cadence of one push-up every three seconds (the cadence CD found in *Fitnessgram 8.0 Stand-Alone Test Kit* may be used) until a second form correction (the first form correction does not count) is made, or they can no longer continue.
5. The scorekeeper will count how many times the cadet can complete a push-up (which is the push-up score).
6. Have the cadets switch positions and repeat Steps 1–5.

## Shoulder Stretch

### Objective:

The shoulder stretch is an assessment of upper arm and shoulder flexibility.

This assessment is conducted by reaching one arm over the shoulder on the same side, and the other arm behind the back to touch the fingertips.

### Scoring:

Scoring for the shoulder stretch is based on the participant's ability to touch their fingers on both their right and left sides. The score is indicated with a yes (Y) or no (N) on the scoresheet.

### Equipment Required:

There is no equipment required for the shoulder stretch.

### Set-Up:

The shoulder stretch station should be large enough to accommodate the participants.

### Conducting the Shoulder Stretch:

1. Have one cadet from each pair test their right shoulder by:
  - a. reaching with the right hand over the right shoulder and down the back; and
  - b. reaching with the left hand behind the back to touch the right hand (as illustrated in Figure G-1).

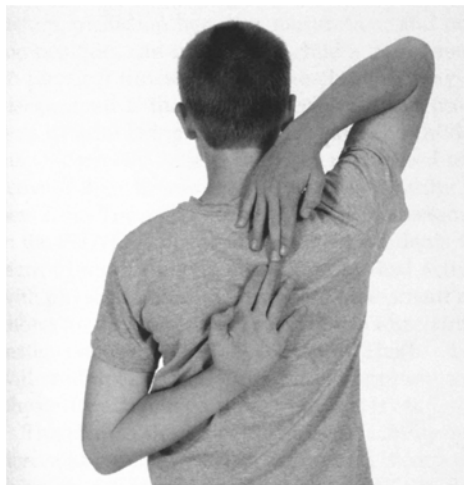

Figure G-1 Right Shoulder Stretch

*Note.* From *Fitnessgram / Activitygram: Test Administration Manual* (3rd ed.) (p. 55), by The Cooper Institute, 2005, Windsor, ON: Human Kinetics. Copyright 2005 by The Cooper Institute.

2. The scorekeeper will observe if the hands are touching to determine the right shoulder stretch score (a yes or no).
3. Have the cadet test their left shoulder by:
  - a. reaching with the left hand over the left shoulder and down the back; and
  - b. reaching with the right hand behind the back to touch the left hand (as illustrated in Figure G-2).

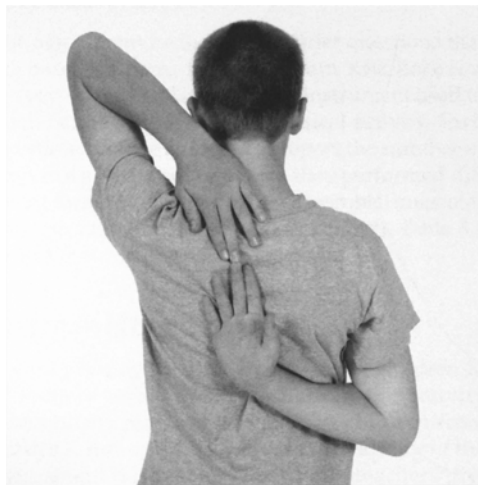

Figure G-2 Left Shoulder Stretch

*Note.* From *Fitnessgram / Activitygram: Test Administration Manual* (3rd ed.) (p. 55), by The Cooper Institute, 2005, Windsor, ON: Human Kinetics. Copyright 2005 by The Cooper Institute.

4. The scorekeeper will observe if the hands are touching to determine the left shoulder stretch score.
5. Have the cadets switch positions and repeat Steps 1–4.

## Back-Saver Sit and Reach

### Objective:

The back-saver sit and reach tests hamstring flexibility for each leg.

This assessment is conducted by placing the foot flat against the test apparatus, bending the other leg and reaching forward with both hands. The same procedure is repeated for the other leg.

### Scoring:

Scoring for the back-saver sit and reach is based on the distance (in inches) that the participant can reach with their hands for each leg, to a maximum of 30 cm (12 inches).

### Equipment Required:

The only piece of equipment required for the back-saver sit and reach assessment is the test apparatus.

### Set-Up:

1. Ensure that there are enough test apparatuses for the number of groups.
2. Spread out each back-saver sit and reach station to allow enough room for the participants and their scorekeepers.

### Conducting the Back-Saver Sit and Reach:

1. Have one cadet from each pair remove their shoes.
2. Have the cadet:
  - a. sit in front of the test apparatus;
  - b. extend one leg fully with the foot flat against the face of the box;
  - c. bend the knee of the other leg with the sole of the foot flat on the floor placed next to the knee of the straight leg;
  - d. ensure that there is a 5- to 8-cm (2-to 3-inch) space between the knee on the straight leg, and the foot of the bent leg; and
  - e. extend their arms forward with the hands placed on top of one another placing the finger tips just in front of the tip of the ruler (as illustrated in Figure H-1).



Figure H-1 Starting Position for the Back-Saver Sit and Reach

*Note.* From *Fitnessgram / Activitygram: Test Administration Manual* (3rd ed.) (p. 54), by The Cooper Institute, 2005, Windsor, ON: Human Kinetics. Copyright 2005 by The Cooper Institute.

3. Have the cadet reach forward with both hands along the scale four times, holding the position on the fourth reach for at least one second (as illustrated in Figure H-2).

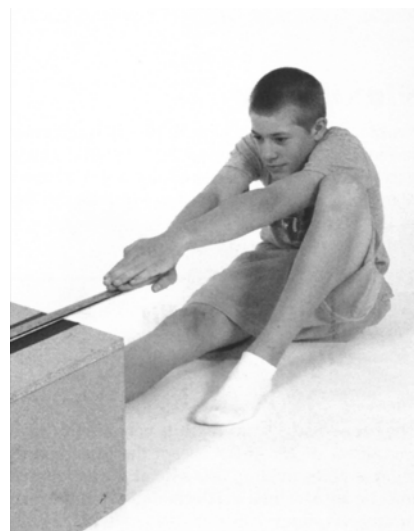

Figure H-2 The Back-Saver Sit and Reach

*Note.* From *Fitnessgram / Activitygram: Test Administration Manual* (3rd ed.) (p. 54), by The Cooper Institute, 2005, Windsor, ON: Human Kinetics. Copyright 2005 by The Cooper Institute.

4. The scorekeeper will measure the distance in inches that the cadet reached. This measurement will be the score for one leg, to a maximum of 12 inches to prevent hyperextension.
5. Have the cadet repeat steps one to three for the other leg.
6. Have the cadets switch positions and repeat Steps 1–4.

## HOW TO CONSTRUCT THE BACK-SAVER SIT AND REACH TEST APPARATUS

The test apparatus (as illustrated in Figure I-1) is constructed in the following fashion:

1. Construct or locate a cardboard / wooden box measuring approximately 30 cm (12 inches) high.
2. Attach a metre stick to the top of the box with the nine inch mark at the nearest edge of the box where the participant will rest their foot and the zero end closest to the participant.

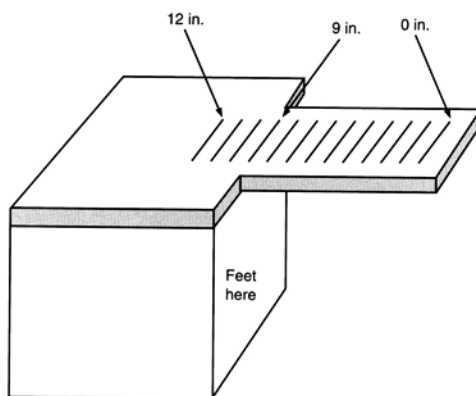

Figure I-1 Back-Saver Sit and Reach Measuring Apparatus

*Note.* From *Fitnessgram / activitygram: Test administration manual* (3rd ed.) (p. 84), by The Cooper Institute, 2005, Windsor, ON: Human Kinetics. Copyright 2005 by The Cooper Institute.

THIS PAGE INTENTIONALLY LEFT BLANK





**COMMON TRAINING  
PROFICIENCY LEVEL FOUR  
INSTRUCTIONAL GUIDE**



**SECTION 2**

**EO M404.02 – UPDATE PERSONAL ACTIVITY PLAN**

---

Total Time: 30 min

---

**PREPARATION**

---

**PRE-LESSON INSTRUCTIONS**

Resources needed for the delivery of this lesson are listed in the lesson specification located in A-CR-CCP-804/PG-001, *Proficiency Level Four Qualification Standard and Plan*, Chapter 4. Specific uses for said resources are identified throughout the instructional guide within the TP for which they are required.

Review the lesson content and become familiar with the material prior to delivering the lesson.

Photocopy Attachment A (Sample Personal Activity Plan) and Attachment B (Personal Activity Plan) for each cadet.

Physical fitness resources can be printed or ordered from <http://www.phac-aspc.gc.ca/pau-uap/fitness/downloads.html>, through the Public Health Agency of Canada to be given as handouts to the cadets.

**PRE-LESSON ASSIGNMENT**

Ensure the cadets have a copy of their Proficiency Level Three Personal Activity Plan and their Cadet Fitness Assessment results to bring to this lesson.

**APPROACH**

A practical activity was chosen for this lesson as it is an interactive way to allow the cadets to update their Personal Activity Plan. This activity contributes to the development of personal fitness goals in a fun and challenging setting.

---

**INTRODUCTION**

---

**REVIEW**

Nil.

**OBJECTIVES**

By the end of this lesson the cadet shall have updated their Personal Activity Plan (from Proficiency Level Three) for the current training year.

## **IMPORTANCE**

In order to help achieve success in physical fitness, it is important to know how to set personal fitness goals and to create an activity plan that will help to achieve those goals. This is important as physical fitness is one of the aims of the cadet program.

**Teaching Point 1****Have the cadets update their Personal Activity Plan from Proficiency Level Three.**

Time: 25 min

Method: Practical Activity



Describe the terms used in the Personal Activity Plan before having the cadets update their plan. Distribute the sample Personal Activity Plan handout located at Attachment A to each cadet.

A Personal Activity Plan is designed to identify current personal fitness level and to create individual goals to increase fitness level. There are a number of terms used within a Personal Activity Plan to describe type and intensity of activities.

**TYPES OF ACTIVITIES**

**Rest activities.** Activities that involve minimal physical effort (eg, homework, computer games and reading).

**Lifestyle activities.** Activities that are a part of a normal day (eg, walking, household chores and garbage sweeps).

**Aerobic activities.** Activities that improve aerobic fitness (eg, jogging, swimming and dancing).

**Aerobic sports.** Sports that involve a great deal of movement (eg, baseball, basketball and soccer).

**Muscular activities.** Activities that require strength (eg, weightlifting, wrestling and track and field sports).

**Flexibility activities.** Activities that involve stretching the muscles (eg, martial arts, stretching and yoga).

**INTENSITY OF ACTIVITIES**

**Rest.** Activities that involve sitting or standing, and little motion.

**Light.** Activities that involve slow movements, and are not tiring.

**Moderate.** Activities that are fairly intense (fall between light and vigorous).

**Vigorous.** Activities that involve quick movements or running, and increased respiration.

**ACTIVITY****OBJECTIVE**

The objective of this activity is to have the cadets update their Proficiency Level Three Personal Activity Plan.

**RESOURCES**

- Personal Activity Plan handout located at Attachment B,
- Cadet Fitness Assessment results, and
- Pens / pencils.

**ACTIVITY LAYOUT**

Nil.

## ACTIVITY INSTRUCTIONS

1. Discuss how the results of the Cadet Fitness Assessment can be used to create goals.



The Cadet Fitness Assessment determines personal fitness level through raw scores.

A cadet who scored 5 on the push-up and 10 on the curl-up assessments, may wish to set a long-term goal to improve muscular fitness. Their short-term goal may be to complete 8 push-ups and 12 curl-ups on the next assessment.

2. Distribute the Personal Activity Plan handout, located at Attachment B, to each cadet.
3. Supervise and provide assistance while the cadets update their Personal Activity Plans for the current training year by:
  - a. reviewing their Proficiency Level Three Personal Activity Plan;
  - b. reviewing their Cadet Fitness Assessment results;
  - c. listing current fitness and sports activities;
  - d. identifying areas that need improvement;
  - e. creating goals; and
  - f. listing planned fitness and sports activities.

## SAFETY

Nil.

---

## CONFIRMATION OF TEACHING POINT 1

The cadets' participation in the activity will serve as the confirmation of this TP.

---

## END OF LESSON CONFIRMATION

The cadets' updating their Personal Activity Plan will serve as the confirmation of this lesson.

---

## CONCLUSION

---

## HOMEWORK / READING / PRACTICE

The cadets should follow their Personal Activity Plan throughout the training year. The Personal Activity Plan will be evaluated by the cadet each time they complete the Cadet Fitness Assessment.

## METHOD OF EVALUATION

Nil.

## CLOSING STATEMENT

One of the aims of the cadet program is physical fitness. A Personal Activity Plan is an important tool for creating and achieving goals, and will help to track progress in physical fitness.

**INSTRUCTOR NOTES / REMARKS**

This lesson shall follow the start of year Cadet Fitness Assessment (EO M404.01 [Participate in the Cadet Fitness Assessment]).

Physical fitness resources can be printed or ordered from <http://www.phac-aspc.gc.ca/pau-uap/fitness/downloads.html>, through the Public Health Agency of Canada to be given as handouts to the cadets.

---

**REFERENCES**

---

C0-104 ISBN 0-662-26628-5 Public Health Agency of Canada. (1998). *Handbook for Canada's physical activity guide to healthy active living*. Ottawa, ON: Public Health Agency of Canada.

C0-105 ISBN 0-662-32897-3 Public Health Agency of Canada. (2002). *Teacher's guide to physical activity for youth 10–14 years of age*. Ottawa, ON: Her Majesty the Queen in Right of Canada.

C0-106 ISBN 0-662-32899-X Public Health Agency of Canada. (2002). *Let's get active! Magazine for youth 10–14 years of age*. Ottawa, ON: Her Majesty the Queen in Right of Canada.

C0-167 ISBN 0-7360-5866-4 Meredith, M., & Welk, G. (Eds.). (2005). *Fitnessgram / activitygram: Test administration manual* (3rd ed.). Windsor, ON: Human Kinetics.

C0-174 ISBN 978-0-7360-6828-4 Masurier, G., Lambdin, D., & Corbin, C. (2007). *Fitness for life: Middle school: Teacher's guide*. Windsor, ON: Human Kinetics.

THIS PAGE INTENTIONALLY LEFT BLANK

## SAMPLE PERSONAL ACTIVITY PLAN

Name: Shepherd, John

Date: 10 Sept

### START OF YEAR

#### CADET FITNESS ASSESSMENT #1 RESULTS

Assessment	Score
<b>Cardiovascular</b>	
20-m Shuttle Run Test	8
<b>Muscular Strength</b>	
Curl-up	20
Push-up	6
<b>Muscular Flexibility</b>	
Trunk Lift	6 inches
Shoulder Stretch	<b>Right:</b> Y
	<b>Left:</b> N
Back-Saver Sit and Reach	<b>Right:</b> 4 inches
	<b>Left:</b> 3 inches

#### CURRENT ACTIVITIES

List the activities that you participated in over the past week.

Date	Activity	Duration	Type of Activity	Intensity of Activity
Wednesday 3 Sept	Computer Games	3 hrs	Rest Activity	Rest
	Soccer	1 hr	Aerobic Sports	Moderate
	Stretching	15 min	Flexibility Activity	Light
Thursday 4 Sept	Soccer	1 hr	Aerobic Sports	Moderate
	Stretching	15 min	Flexibility Activity	Light
	Reading	2 hrs	Rest Activity	Rest
Friday 5 Sept	Yard Work	1 hr	Lifestyle Activity	Moderate
	Bike Riding	1 hr	Aerobic Activity	Moderate
	Watching Television	4 hrs	Rest Activity	Rest
Saturday 6 Sept	Bike Riding	1 hr	Aerobic Activity	Moderate
	Packing	3 hrs	Lifestyle Activity	Light
	Reading	1 hr	Rest Activity	Rest

Date	Activity	Duration	Type of Activity	Intensity of Activity
Sunday 7 Sept	Playing Video Games	2 hrs	Rest Activity	Rest
	Walking	30 min	Lifestyle Activity	Light
	Reading	1 hr	Rest Activity	Rest
Monday 8 Sept	Watching TV	3 hrs	Rest Activity	Rest
	Walking	1 hr	Lifestyle Activity	Light
	Reading	1 hr	Rest Activity	Rest
Tuesday 9 Sept	Sitting in Class	4 hrs	Rest Activity	Rest
	Reading	1 hr	Rest Activity	Rest
	Walking	1 hr	Lifestyle Activity	Light

**Areas That Need Improvement:**

1. 20-m Shuttle Run Test score is low. Need to improve cardiovascular fitness.
2. Need to participate in more activities at a vigorous intensity.
3. Cut back on rest activities.

**GOALS**

Remember that goals must be:

- Specific,
- Measurable,
- Achievable,
- Relevant, and
- Timed.

**Long-term goal for the training year:** To increase personal fitness level.

**Short-term Goals:**

Goal	Date to Achieve By	Date Achieved
Score 15 on the 20-m Shuttle Run Test	Next Cadet Fitness Assessment	
Score 10 on the push-up assessment	Next Cadet Fitness Assessment	
Participate in five aerobic sports in the next week	17 Sept	



## PLANNED ACTIVITIES

List the activities that you plan to participate in.

<b>Week</b>	<b>Activity</b>	<b>Was the activity completed?</b>	<b>Why was the activity not completed?</b>
11 Sept- 17 Sept	Soccer for 2 hrs		
	Walking for 30 min / day		
	Biking for 2 hrs / twice a week		
18 Sept- 24 Sept	Run for 1 hrs		
	Recreational Sports for 1 hr		
	Walking for 30 min / day		
25 Sept- 1 Oct	Soccer for 2 hrs		
	Walking for 30 min / day		
	Swimming for 1.5 hrs		
2 Oct- 8 Oct	Biking for 2 hrs / twice a week		
	Recreational Sports for 1 hr / twice a week		
	Walking for 30 min / day		
9 Oct- 15 Oct	Recreational Sports for 1 hr / twice a week		
	Running / Walking for 30 min / day		
	Biking for 2 hrs / twice a week		
16 Oct- 22 Oct	Recreational Sports for 1 hr / twice a week		
	Running / Walking for 30 min / day		
	Biking for 2 hrs / twice a week		
23 Oct- 29 Oct	Recreational Sports for 1 hr / twice a week		
	Running / Walking for 30 min / day		
	Biking for 2 hrs / twice a week		

*Note.* Created by Director Cadets 3, 2008, Ottawa, ON: Department of National Defence.

THIS PAGE INTENTIONALLY LEFT BLANK

## PERSONAL ACTIVITY PLAN

Name: \_\_\_\_\_

Date: \_\_\_\_\_

### START OF YEAR

#### CADET FITNESS ASSESSMENT RESULTS

Assessment	Score
<b>Cardiovascular</b>	
20-m Shuttle Run Test	
<b>Muscular Strength</b>	
Curl-up	
Push-up	
<b>Muscular Flexibility</b>	
Trunk Lift	
Shoulder Stretch	<b>Right:</b>
	<b>Left:</b>
Back-Saver Sit and Reach	<b>Right:</b>
	<b>Left:</b>

#### CURRENT ACTIVITIES

List the activities that you participated in over the past week.

Date	Activity	Duration	Type of Activity	Intensity of Activity

Date	Activity	Duration	Type of Activity	Intensity of Activity

**Areas That Need Improvement:**

1. \_\_\_\_\_
2. \_\_\_\_\_
3. \_\_\_\_\_

**GOALS**

Remember that goals must be:

- Specific,
- Measurable,
- Achievable,
- Relevant, and
- Timed.

**Long-term goal for the training year:** \_\_\_\_\_

**Short-term Goals:**

Goal	Date to Achieve By	Date Achieved



## **END OF YEAR**

### **CADET FITNESS ASSESSMENT RESULTS**

<b>Assessment</b>	<b>Score</b>
<b>Cardiovascular</b>	
20-m Shuttle Run Test	
<b>Muscular</b>	
Curl-up	
Push-up	
<b>Flexibility</b>	
Trunk Lift	
Shoulder Stretch	<b>Right:</b>
	<b>Left:</b>
Back-saver Sit and Reach	<b>Right:</b>
	<b>Left:</b>

#### **Areas That Need Improvement:**

1. \_\_\_\_\_
2. \_\_\_\_\_
3. \_\_\_\_\_

#### **Short-term Goals:**

<b>Goal</b>	<b>Date to Achieve By</b>	<b>Date Achieved</b>



## **REFLECTION**

Was your long-term goal for the training year met? \_\_\_\_\_

If applicable, why was your long-term goal not met? \_\_\_\_\_

What is your long-term goal following the completion of this training year? \_\_\_\_\_

**List some short-term goals that will help you achieve your long-term goal:**

<b>Goal</b>	<b>Date to Achieve By</b>	<b>Date Achieved</b>

*Note.* Created by Director Cadets 3, 2008, Ottawa, ON: Department of National Defence.





**COMMON TRAINING  
PROFICIENCY LEVEL FOUR  
INSTRUCTIONAL GUIDE**



**SECTION 3**

**EO M404.03 – EVALUATE PERSONAL ACTIVITY PLAN**

Total Time:

30 min

**PREPARATION**

**PRE-LESSON INSTRUCTIONS**

Resources needed for the delivery of this lesson are listed in the lesson specification located in A-CR-CCP-804/PG-001, *Proficiency Level Four Qualification Standard and Plan*, Chapter 4. Specific uses for said resources are identified throughout the instructional guide within the TP for which they are required.

Review the lesson content and become familiar with the material prior to delivering the lesson.

**PRE-LESSON ASSIGNMENT**

Nil.

**APPROACH**

A practical activity was chosen for this lesson as it allows the cadets to evaluate their Personal Activity Plan in a safe and controlled environment.

**INTRODUCTION**

**REVIEW**

Nil.

**OBJECTIVES**

By the end of this lesson the cadet shall have evaluated their Personal Activity Plan.

**IMPORTANCE**

It is important for cadets to evaluate their Personal Activity Plan to determine if goals were met and to track progress in personal fitness.

---

**Teaching Point 1**

**Have the cadets evaluate their Personal Activity Plan.**

Time: 25 min

Method: Practical Activity

---

**ACTIVITY**

**OBJECTIVE**

The objective of this activity is to have the cadets evaluate their Personal Activity Plan.

**RESOURCES**

- Cadet Fitness Assessment results, and
- Personal Activity Plan from the start of the training year.

**ACTIVITY LAYOUT**

Nil.

**ACTIVITY INSTRUCTIONS**

1. Distribute the cadet's Personal Activity Plan and Cadet Fitness Assessment results.
2. Have the cadets compare their start of year and end of year Cadet Fitness Assessment results.
3. Have the cadets compare their actual and planned fitness and sports activities.
4. Have the cadets complete the reflection portion of the Personal Activity Plan.

**SAFETY**

Nil.

---

**CONFIRMATION OF TEACHING POINT 1**

The cadet's evaluation of their Personal Activity Plan will serve as the confirmation of this TP.

---

**END OF LESSON CONFIRMATION**

The cadet's evaluation of their Personal Activity Plan will serve as the confirmation of this lesson.

---

**CONCLUSION**

---

**HOMEWORK / READING / PRACTICE**

Nil.

**METHOD OF EVALUATION**

Nil.

**CLOSING STATEMENT**

Evaluating a Personal Activity Plan will help determine if goals were met and track progress in personal fitness. This lesson promotes physical fitness, meeting one of the aims of the cadet program.

**INSTRUCTOR NOTES / REMARKS**

This lesson shall follow the end of year Cadet Fitness Assessment (EO M404.02 [Participate in the Cadet Fitness Assessment]).

Physical fitness resources can be printed or ordered from <http://www.phac-aspc.gc.ca/pau-uap/fitness/downloads.html>, through the Public Health Agency of Canada to be given as handouts to the cadets.

---

**REFERENCES**

---

C0-104 ISBN 0-662-26628-5 Public Health Agency of Canada. (1998). *Handbook for Canada's physical activity guide to healthy active living*. Ottawa, ON: Public Health Agency of Canada.

C0-105 ISBN 0-662-32897-3 Public Health Agency of Canada. (2002). *Teacher's guide to physical activity for youth 10–14 years of age*. Ottawa, ON: Her Majesty the Queen in Right of Canada.

C0-106 ISBN 0-662-32899-X Public Health Agency of Canada. (2002). *Let's get active! Magazine for youth 10–14 years of age*. Ottawa, ON: Her Majesty the Queen in Right of Canada.

C0-167 ISBN 0-7360-5866-4 Meredith, M., & Welk, G. (Eds.). (2005). *Fitnessgram / activitygram: Test administration manual* (3rd ed.). Windsor, ON: Human Kinetics.

C0-174 ISBN 978-0-7360-6828-4 Masurier, G., Lambdin, D., & Corbin, C. (2007). *Fitness for life: Middle school: Teacher's guide*. Windsor, ON: Human Kinetics.

THIS PAGE INTENTIONALLY LEFT BLANK



**COMMON TRAINING  
PROFICIENCY LEVEL FOUR  
INSTRUCTIONAL GUIDE**



**SECTION 4**

**EO C404.01 – DESCRIBE NUTRITION AND HYDRATION  
REQUIREMENTS FOR FITNESS AND SPORTS ACTIVITIES**

---

Total Time:

60 min

---

**PREPARATION**

---

**PRE-LESSON INSTRUCTIONS**

Resources needed for the delivery of this lesson are listed in the lesson specification located in A-CR-CCP-804/PG-001, *Proficiency Level Four Qualification Standard and Plan*, Chapter 4. Specific uses for said resources are identified throughout the instructional guide within the TP for which they are required.

Review the lesson content and become familiar with the material prior to delivering the lesson.

Photocopy the handouts located at Attachments A, B and D–G for each cadet.

**PRE-LESSON ASSIGNMENT**

Have each cadet collect two food labels (one of a food and one of a fluid) from items they commonly consume and bring them to this lesson.

**APPROACH**

An interactive lecture was chosen for TPs 1 and 3 to orient the cadets to food labels and to the relationship between nutrition, hydration and fitness and sports activities.

An in-class activity was chosen for TP 2 as it is an interactive way for the cadets to estimate daily energy requirements.

---

**INTRODUCTION**

---

**REVIEW**

Nil.

**OBJECTIVES**

By the end of this lesson the cadet shall have described the nutrition and hydration requirements for fitness and sports activities.

## **IMPORTANCE**

It is important for the cadets to have an understanding of the nutrition and hydration requirements for fitness and sports activities because research has proven that eating healthy foods will help the body to grow strong and prevent illnesses. The information in this lesson will assist with choosing healthy foods to meet energy requirements for fitness and sports activities.

---

**Teaching Point 1****Explain food labels.**

Time: 15 min

Method: Interactive Lecture

---



Distribute the *Nutrition Facts* handout located at Attachment A to each cadet.

**PURPOSE OF NUTRITION INFORMATION**

The nutrition information found on food labels is regulated by Health Canada through the *Food and Drugs Act* and includes an ingredients list, nutrition facts table and nutrition claims. This information makes it easier to:

- compare products;
- determine the nutritional value of foods;
- manage special diets; and
- increase or decrease intake of a particular nutrient.

**INGREDIENTS LIST**

Ingredients are listed by weight from highest to lowest. The ingredients list provides information for people who have food allergies and / or those who are avoiding specific foods.

**NUTRITION FACTS TABLE**

The nutrition facts table contains information on calories and important nutrients for a specified amount (serving) of the food. The core nutrients are listed in the table and include the amount (usually in grams or milligrams) and the percentage of daily value that is contained in the food. The daily value refers to the amount of a specific nutrient that is recommended each day. Vitamins and minerals are listed only by the percentage of the daily value.

Nutrition Facts	
Per 125 mL (87 g)	
Amount	% Daily Value
<b>Calories 80</b>	
<b>Fat</b> 0.5 g	<b>1 %</b>
Saturated 0 g + Trans 0 g	<b>0 %</b>
<b>Cholesterol</b> 0 mg	
<b>Sodium</b> 0 mg	<b>0 %</b>
<b>Carbohydrate</b> 18 g	<b>6 %</b>
Fibre 2 g	<b>8 %</b>
Sugars 2 g	
<b>Protein</b> 3 g	
Vitamin A 2 %	Vitamin C 10 %
Calcium 0 %	Iron 2 %

Figure 1 Nutrition Facts Table

Note. From *Food & Nutrition*. Retrieved November 1, 2007, from [http://www.hc-sc.gc.ca/fn-an/label-etiquet/nutrition/education/cons-res/cr\\_tearsheet-cr\\_fiche\\_e.html](http://www.hc-sc.gc.ca/fn-an/label-etiquet/nutrition/education/cons-res/cr_tearsheet-cr_fiche_e.html)



Direct the cadets to the example on the *Nutrition Facts* handout when describing the nutrition facts table. Other examples of food labels may be used as well.

## Core Nutrients

**Calories.** A calorie is a measurement of food energy.

**Fat.** Fat as listed in the table includes saturated, trans, and all other fatty acids present in the food by quantity.

**Saturated and trans fats.** Saturated and trans fats are listed in the table because they may have a negative impact on health and should be consumed in moderation.

**Cholesterol.** Cholesterol is one of the fats found in blood. It is used to make cell membranes, vitamin D and hormones. There are two main types of cholesterol: low-density lipoprotein (LDL) cholesterol, which is considered the bad cholesterol and high-density lipoprotein (HDL) cholesterol, which is considered the good cholesterol. Cholesterol is listed in the table because high blood cholesterol is a risk factor for heart disease and stroke.

**Sodium.** Most sodium in food comes from sodium chloride, which is table or sea salt. Salt is a common ingredient in processed and prepared foods. Most people consume more salt than they require. Sodium is listed in the table because a low-sodium diet will reduce the risk of high blood pressure, stroke, and heart disease.

**Carbohydrate.** Carbohydrates are a primary source of energy for the body. There are two types of carbohydrates listed in the table: fibre, which is a complex carbohydrate, and sugar, which is a simple carbohydrate.

**Fibre.** Fibre is a complex carbohydrate found in plants. Unlike other carbohydrates it passes through the body undigested and is healthy for the digestive system. Fibre is listed in the table because it provides energy for the muscles and brain.





**Complex carbohydrates.** Complex carbohydrates break down slowly and can help prevent overeating. They are found in vegetables, fruit, whole grains, brown rice, nuts, soy products, and legumes.

**Sugars.** Sugar is a simple carbohydrate. Natural sugars are found in foods such as milk, fruit, and vegetables. Added sugars contribute calories and have no significant nutritional value. Sugars are listed in the table because some diets require sugars to be limited (eg, diabetics).



**Simple carbohydrates.** Simple carbohydrates break down quickly and can cause a person to become hungry quickly. They are found in sugary soft drinks, sugary cereals, white bread, white rice, cookies, candy, fries, and pastries.

**Protein.** Protein is found in a variety of foods such as meat, poultry, fish, legumes, nuts, milk products, and grain products. It is listed in the table because protein builds muscles, bones, and teeth.

**Vitamin A.** Vitamin A is found in many vegetables and fruit. It is listed in the table because it will help keep skin healthy and low-light vision functional.

**Vitamin C.** Vitamin C is found in many vegetables and fruit. It is listed in the table because it will help the body fight infections.

**Calcium.** Calcium is found in milk and alternative foods. It is listed in the table because it will build strong bones and reduce the risk of osteoporosis (a disease where bones degenerate and become brittle).

**Iron.** Iron is found in foods such as meat, fish, poultry, grains, vegetables, fruit, nuts, and seeds. It is listed in the table because it helps the red blood cells carry oxygen throughout the body.

## NUTRITION CLAIMS

A nutrition claim must meet a set of government rules before it may be printed on a food label. They may highlight a relation between diet and disease (eg, a healthy diet rich in a variety of vegetables and fruit may help reduce the risk of some types of cancer). Nutrition claims may include the following words / phrases:

- free,
- low,
- less,
- more,
- reduced,
- lower,
- very high,
- light / lite,
- source of,
- high source of,
- good source of, and
- excellent source of.

## CONFIRMATION OF TEACHING POINT 1

### QUESTIONS:

- Q1. How are food labels regulated?
- Q2. How are ingredients listed on food labels?
- Q3. What are three words that may be included in a nutrition claim?

### ANTICIPATED ANSWERS:

- A1. Health Canada regulates food labels through the *Food and Drugs Act*.
- A2. Ingredients are listed by weight from highest to lowest on food labels.
- A3. Nutrition claims may include the following words / phrases:
- free,
  - low,
  - less,
  - more,
  - reduced,
  - lower,
  - very high,
  - light / lite,
  - source of,
  - high source of,
  - good source of, and
  - excellent source of.



Offer the cadets the opportunity to further evaluate their learning by distributing the Nutrition Facts Quiz located at Attachment B. Tell the cadets the Nutrition Facts Quiz Answer Key located at Attachment C will be posted in a common area.

**Teaching Point 2****Conduct an activity where the cadets will estimate their daily energy requirements.**

Time: 20 min

Method: In-Class Activity

Daily energy expenditures vary from one person to the other. Daily energy expenditures come from three sources:

1. resting energy expenditure,
2. thermic effect of food, and
3. caloric requirements for daily life.

**RESTING ENERGY EXPENDITURE (REE)**

REE is the minimum amount of energy (expressed in kilocalories [commonly referred to as calories] per day) our body needs to stay alive while at rest. This is the energy needed for actions such as breathing, digesting and keeping a heartbeat. REEs consist of about 60–70 percent of your daily energy needs. It may vary as much as 20 percent between individuals. Numerous factors account for this variation, such as:

- age,
- muscle mass,
- height and weight,
- gender, and
- amount of food consumed (overeating increases resting energy output while food restriction lowers it).



The Energy Expenditures for Physical Activity Table handout located at Attachment D, the Estimated Daily Energy Requirements worksheet located at Attachment E and the Resting Energy Expenditures Table handout located at Attachment F only serve as guidance. They are only used to *estimate* the resting energy expenditure.

**THERMIC EFFECT OF FOOD**

Energy that is used by the body to digest and absorb the food is lost in the form of heat. This is called the thermic effect of food and varies depending on the type and amount of food eaten. It accounts for about 10 percent of energy output.

**CALORIC REQUIREMENTS FOR DAILY LIFE**

Each day's activities (eg, working, studying or playing sports) expend energy. The more active an individual is, the higher their caloric requirements.

Caloric needs vary based on the amount and intensity of the physical fitness activities. When an individual's physical fitness activities change, their eating habits should reflect those changes.



Distribute the Energy Expenditures for Physical Activity Table handout located at Attachment D to each cadet. Ask them what they find interesting and surprising from the chart.

---

## ACTIVITY

Time: 15 min

### OBJECTIVE

The objective of this activity is to have the cadets estimate their caloric need based on their daily activities.

### RESOURCES

- Energy Expenditures for Physical Activity Table handout located at Attachment D,
- Estimated Daily Energy Requirements worksheet located at Attachment E,
- Resting Energy Expenditures Table handout located at Attachment F,
- Estimated Number of Servings table located at Attachment G,
- Pens / pencils, and
- Calculators.

### ACTIVITY LAYOUT

Nil.

### ACTIVITY INSTRUCTIONS

1. Distribute the Estimated Energy Requirements worksheets.
2. Have the cadets fill out the worksheet using other provided attachments.
3. Circulate around the class to help cadets who are experiencing difficulties.

### SAFETY

Nil.

---

### CONFIRMATION OF TEACHING POINT 2

The cadets' participation in the activity will serve as the confirmation of this TP.

---

### Teaching Point 3

**Describe nutrition and hydration requirements for fitness and sports activities.**

Time: 15 min

Method: Interactive Lecture

---

Healthy eating provides the body with essential nutrients and energy. Everyday eating should include at least three meals and healthy snacking. An individual will perform more efficiently if the body's energy levels are consistently maintained.

Glucose is produced when carbohydrate foods are broken down by the digestive track and the liver. Glucose is the body's preferred fuel when performing hard physical work or exercising intensely. As well, the brain, nervous system and red blood cells depend completely on glucose for their fuel.

Carbohydrates are found in foods from all food groups. Fruit and root vegetables provide more than leafy vegetables and legumes (eg, beans, peas, lentils), grain products supply a large amount while seeds and nuts have some.

Carbohydrates and fat provide energy. Carbohydrates are stored in the body in the form of glycogen (a large molecule made up of glucose and water) and fat is stored in the body as fat. During high intensity exercise (eg, sprinting), glucose is the primary source of energy because fat cannot be used when oxygen is in short supply. During low-intensity exercise (eg, walking), cells use glucose and fat for energy since oxygen is available and make it possible for fat to be used. A well-conditioned individual has better oxygen delivery and can therefore use more fat than an individual with a lower fitness level.

Glycogen is used when necessary. The body can store only a small amount of glycogen. Glycogen is stored in the liver and the muscles. When the blood glucose level gets low, glycogen from the liver is converted to glucose and moved to the blood stream. Glycogen stored in the muscles is for muscle use only.

### **PRE-EXERCISE NUTRITION**

Since carbohydrates are the fuel for high intensity workouts it is important to consume them prior to exercising. When there are too few carbohydrates, the body changes protein into glucose to provide energy, and prevents the proteins from doing their job (supply amino acids to build muscles, hormones, enzymes and other chemicals).

#### **Time to Allow Between Meal and Activity**

The length of time between a meal and a fitness or sports activity determines how much and what you should eat. Ideally, there should be:

- a 3- to 4-hour period to digest a large meal containing carbohydrates, protein and some fat;
- a 2- to 3-hour period to digest a small meal; or
- a 1- to 2-hour period for a carbohydrate snack or liquid meal.

#### **Foods to Choose**

Use the following guidelines when choosing food prior to fitness and sports activities:

- Drink fluids, such as water, fruit juice, milk or soup.
- Select foods high in carbohydrates, such as grain products, vegetables and fruit juice, low-fat milk or yogurt. Beans, peas and lentils are sources of slowly released carbohydrate, but unless they are eaten regularly these high fibre foods might cause discomfort.
- Select foods that are easy to digest. Since proteins and fats are digested slowly, it is better to limit them, particularly fat, especially if exercising intensely soon after eating.
- Select familiar foods in order not to upset the stomach.
- Avoid spicy or high in fibre foods unless they can be tolerated.

### **DURING EXERCISE**



Water is essential. Even a small amount of dehydration (1 percent of body weight) can increase cardiovascular strain as indicated by a disproportionate elevation of heart rate during exercise and limit the ability of the body to transfer heat from contracting muscles to the skin's surface where heat can be dissipated to the environment.

For fitness and sports activities less than one hour, water is all that is needed.

For fitness and sports activities that are longer than an hour, a high demand is placed on stored energy. Consuming carbohydrates during the activity will delay fatigue and improve performance. According to the American College of Sports Medicine (ACSM) Fitness Book, "Several research studies have demonstrated the improved performance potential of ingesting carbohydrates during activity, so this should be an important strategy for all persons involved in regular physical activity".

For fitness and sports activities longer than one hour, carbohydrates (from fluids or foods) should be consumed to maintain the blood glucose level and preserve glycogen stores. For training sessions that last several hours, carbohydrate-rich fluids and foods keep energy levels high and help an individual stay focused.

### **What to Drink**

For fitness and sports activities longer than one hour, fluids should contain:

- carbohydrates in concentration of 4–8 percent (which is equivalent to 40–80 g of carbohydrates per litre of fluid), and
- sodium (a pinch of salt) which adds taste and increases fluid intake.

Sports drinks are designed so fluid and some carbohydrates enter your blood stream quickly. They have no other nutrients.

If a fluid has too many carbohydrates, it can be diluted with water to meet the concentration requirements.

Urine volume and colour are simple indicators of hydration status. Ample quantities of lemon juice-coloured urine mean an individual is well hydrated while dark coloured, small volume and infrequent urination mean dehydration.

### **What to Eat**

When an individual trains several times a day, there are opportunities to consume solid snacks between workouts. Those snacks should consist of foods that are easy to digest (low in fibre and in fat—less than 3 g of fat per 30-g serving). To maintain energy levels, the intake of carbohydrates during exercise should be between 30 g and 60 g per hour.

### **POST-EXERCISE**

When an individual has been sweating heavily during fitness and sports activities, fluid replacement is the primary concern. Eating carbohydrates within 15 minutes of the end of the fitness or sports activity will refill muscle glycogen stores. Fat will slow the rate of absorption. Directly after physical activity, look for low fat foods, high in carbohydrates with little protein.

---

## **CONFIRMATION OF TEACHING POINT 3**

### **QUESTIONS:**

- Q1. What fluid should be consumed during fitness and sports activities of less than one hour?
- Q2. What is an indicator of hydration status and how does it indicate it?
- Q3. What is the primary concern after exercising?

**ANTICIPATED ANSWERS:**

- A1. Water is to be consumed during fitness and sports activities of less than one hour.
- A2. Urine volume and colours are indicators of hydration status. Ample quantities of lemon juice-coloured urine indicate good hydration while dark coloured, small volume infrequent urination indicates dehydration.
- A3. Fluid replacement is the primary concern after exercising.
- 

**END OF LESSON CONFIRMATION****QUESTIONS:**

- Q1. What is the purpose of including an ingredients list, nutrition facts table and nutrition claims on a food label?
- Q2. What factors account for the REE variation between individuals?
- Q3. What is the body's preferred fuel when performing hard physical work or exercising intensely?

**ANTICIPATED ANSWERS:**

- A1. This information makes it easier to:
- compare products;
  - determine the nutritional value of foods;
  - manage special diets; and
  - increase or decrease intake of a particular nutrient.
- A2. REE variation can be accounted for by factors, such as:
- age,
  - muscle mass,
  - height and weight,
  - gender, and
  - amount of food consumed (overeating increases resting energy output while food restriction lowers it).
- A3. The body's preferred fuel when performing hard physical work or exercising intensely is glucose.
- 

**CONCLUSION****HOMEWORK / READING / PRACTICE**

Nil.

**METHOD OF EVALUATION**

Nil.

## CLOSING STATEMENT

Meeting energy requirements is an important part of performing well and staying healthy while being active. Eating healthy foods will help the body grow strong, prevent illnesses, and maintain energy. Choosing healthy foods and consuming a sufficient amount of nutrients and energy is important to personal fitness and healthy living.

## INSTRUCTOR NOTES / REMARKS

Nil.

---

## REFERENCES

---

A0-111 A-MD-007-006/PW-001 Department of National Defence. (2005). *Top fuel for top performance*. Ottawa, ON: Department of National Defence.

C0-155 ISBN 0-662-33410-8 Health Canada. (2003). *Nutrition facts*. Ottawa, ON: Her Majesty the Queen in Right of Canada.

C0-166 ISBN 978-0-7360-4602-2 Clark, N. (2003). *Sports nutrition guide book* (3rd ed.). Windsor, ON: Human Kinetics.

C0-175 ISBN 978-0-7360-4406-6 McNeely, E., & McLaughlin, W. (Eds.). (2003). *ACSM fitness book: A proven step-by-step program from the experts*. Windsor, ON: Human Kinetics, Inc

C0-176 ISBN 0-662-33411-6 Health Canada. (2003). *Nutrition labelling...Get the facts!* Ottawa, ON: Her Majesty the Queen in Right of Canada.

C0-178 Health Canada. (2006). *Core nutrients*. Retrieved October 28, 2007, from [http://hc-sc.gc.ca/fn-an/label-etiquet/nutrition/interactive/core\\_nutrients-principaux\\_nutriments\\_e.html](http://hc-sc.gc.ca/fn-an/label-etiquet/nutrition/interactive/core_nutrients-principaux_nutriments_e.html)

C0-180 Heart and Stroke Foundation of Canada. (2007). *Fibre, whole grains and carbohydrates*. Retrieved October 30, 2007, from <http://ww2.heartandstroke.ca/Page.asp?PageID=110&ArticleID=5327&Src=living>

C0-181 Canadian Diabetes Association and Dietitians of Canada. (n.d.). *Look at the label*. Retrieved October 30, 2007, from [http://www.healthyeatinginstore.ca/pdf/Fact\\_ENG.pdf](http://www.healthyeatinginstore.ca/pdf/Fact_ENG.pdf)

C0-182 British Columbia Ministry of Health. (n.d.). *BC health files: Iron and your health*. Retrieved October 30, 2007, from <http://www.bchealthguide.org/healthfiles/pdf/hfile68c.pdf>

C0-320 American College of Sports Medicine. (n.d.). *Exercise and fluid replacement*. Retrieved September 26, 2008 from [http://www.acsm.org/Content/NavigationMenu/Research/Roundtables\\_Specialty\\_Conf/PastRoundtables/Position\\_Stand\\_Fluid\\_Replacement.htm](http://www.acsm.org/Content/NavigationMenu/Research/Roundtables_Specialty_Conf/PastRoundtables/Position_Stand_Fluid_Replacement.htm)

C0-321 BC Dairy Foundation. (n.d.). *Sport nutrition*. Retrieved September 26, 2008, from [http://www.bcdairyfoundation.ca/nutrition\\_education/docs/sportnutrition.pdf](http://www.bcdairyfoundation.ca/nutrition_education/docs/sportnutrition.pdf)

C0-344 VacuMed. (1998). *Resting energy expenditures*. Retrieved October 23, 2008, from <http://www.vacumed.com/293.html>

C0-345 Ionescu, G. (n.d.). *Basal metabolic rate & daily energy requirements calculator*. Retrieved October 23, 2008, from <http://health.drgily.com/basal-metabolic-rate-calculator.php>

C0-346 NutriStrategy. (n.d.) *Calories burned during exercise*. Retrieved October 23, 2008, from <http://www.nutristrateg.com/activitylist4.htm>



C0-348 Manore, M. M., Barr S. I., & Butterfield, G. E. (2000). *Nutrition and athletic performance*. Retrieved October 29, 2008, from [http://www.coach.ca/eng/nutrition/documents/sports\\_nutrition\\_position\\_2000.pdf](http://www.coach.ca/eng/nutrition/documents/sports_nutrition_position_2000.pdf)

THIS PAGE INTENTIONALLY LEFT BLANK



# Nutrition Facts

## To Help You Make Informed Food Choices

The "Nutrition Facts" table is easy to find, easy to read and on more foods

Information in the Nutrition Facts table is based on a specific amount of food. Compare this to the amount you eat.

Use % Daily Value to see if a food has a little or a lot of a nutrient.

Nutrition Facts	
Per 125 mL (87 g)	
Amount	% Daily Value
<b>Calories</b> 80	
<b>Fat</b> 0.5 g	1 %
Saturated 0 g + Trans 0 g	0 %
<b>Cholesterol</b> 0 mg	
<b>Sodium</b> 0 mg	0 %
<b>Carbohydrate</b> 18 g	6 %
Fibre 2 g	8 %
Sugars 2 g	
<b>Protein</b> 3 g	
Vitamin A 2 %	Vitamin C 10 %
Calcium 0 %	Iron 2 %

With the nutrition information on food labels you will be able to:

- Compare products more easily
- Determine the nutritional value of foods
- Better manage special diets
- Increase or decrease your intake of a particular nutrient

## Nutrition Information on Food Labels

Use Nutrition Facts, the list of ingredients and nutrition claims to help you make informed food choices.



To get more complete information about the nutrient value of a food look at the Nutrition Facts table.

### Nutrition Claims

The Government sets rules that must be met before a nutrition claim can be made on a label or advertisement.

A claim highlights a nutrition feature of a food.

Look for one of these words:

free	reduced	source of
low	lower	high source of
less	very high	good source of
more	light/lite	excellent source of

A claim may also highlight a relationship between diet and disease. For example:

- A healthy diet rich in a variety of vegetables and fruit may help reduce the risk of some types of cancer.
- A healthy diet low in saturated and trans fats may reduce the risk of heart disease.

### Ingredient List

- Ingredients in the food are listed by weight from most to least.
- The ingredient list is a source of information for people with allergies or for people who avoid certain ingredients based on their beliefs.

Follow Canada's Food Guide to Healthy Eating and use Nutrition Facts to help you make healthy food choices.

Enjoy eating well, being active and feeling good about yourself.

## NUTRITION FACTS QUIZ

1. **Are the following statements true or false:**

- a. The nutrition facts table contains information on calories and important nutrients for a specific amount (serving) of the food. \_\_\_\_\_
- b. On a label, vitamins are listed only by the percentage of the daily value. \_\_\_\_\_
- c. Ingredients on a label are listed by weight from lowest to highest. \_\_\_\_\_
- d. Nutrition information helps to manage special diets and compare products. \_\_\_\_\_

2. **Match the word to its appropriate definition.**

Vitamin A	Carbohydrate	Cholesterol	Fibre	Sugar	Fat
Iron	Sodium	Vitamin C	Calcium	Calories	Protein

1	Measurement of food energy.	
2	It is a necessary part of your diet because it supplies essential fatty acids and is needed to absorb fat-soluble vitamins (A, D, E and K). It reduces hunger because it is absorbed slowly. It should account for 10–35 percent of the energy of your diet. It provides 9 kcal / g.	.
3	One of the fats found in the blood. It is used to make cell membranes, vitamin D and hormones.	
4	Most of it is from table or sea salt. Most people consume more than they require. Reducing this nutrient will reduce the risk of high blood pressure, stroke, and heart disease.	
5	Primary source of energy for the body. There are two types: fibre, which is a complex one, and sugar, which is a simple one. Should account for 45–65 percent of the energy of your diet. It provides 4 kcal / g.	
6	Complex carbohydrate found in plants. Unlike other carbohydrates it passes through the body undigested and is healthy for the digestive system.	
7	It is a simple carbohydrate. Natural ones are found in foods such as milk, fruit, and vegetables. Added ones contribute calories and have no significant nutritional value.	
8	Found in a variety of foods such as meat, poultry, fish, legumes, nuts, milk products, and grain products. Builds muscles, bones, and teeth. Should account for 10–35 percent of the energy of your diet. It provides 4 kcal / g.	
9	Found in many vegetables and fruit. Helps keep skin and eyesight healthy.	
10	Found in many vegetables and fruit. Helps the body fight infections.	
11	Found in milk and alternative foods. Builds strong bones and reduces the risk of osteoporosis (a disease where bones degenerate and become brittle).	
12	Found in foods such as meat, fish, poultry, grains, vegetables, fruit, nuts, and seeds. Helps the red blood cells carry oxygen throughout the body.	

THIS PAGE INTENTIONALLY LEFT BLANK

## NUTRITION FACTS QUIZ

### Answer Key

1. **Are the following statements true or false:**

- The nutrition facts table contains information on calories and important nutrients for a specific amount (serving) of the food. TRUE
- On a label, vitamins are listed only by the percentage of daily value. TRUE
- Ingredients on a label are listed by weight from lowest to highest. FALSE, it is from highest to lowest, decreasing.
- Nutrition information helps to manage special diet and compare products. TRUE. It also helps to determine the nutritional value of food and gives information for people who need to increase or decrease intake of a particular nutrient.

2. **Match the word to its appropriate definition.**

Vitamin A	Carbohydrate	Cholesterol	Fibre	Sugar	Fat
Iron	Sodium	Vitamin C	Calcium	Calories	Protein

1	Measurement of food energy.	Calories
2	It is a necessary part of your diet because it supplies essential fatty acids and is needed to absorb fat-soluble vitamins (A, D, E and K). It reduces hunger because it is absorbed slowly. It should account for 10–35 percent of the energy of your diet. It provides 9 kcal / g.	Fat
3	One of the fats found in the blood. It is used to make cell membranes, vitamin D and hormones.	Cholesterol
4	Most of it is from table or sea salt. Most people consume more than they require. Reducing this nutrient will reduce the risk of high blood pressure, stroke, and heart disease.	Sodium
5	Primary source of energy for the body. There are two types: fibre, which is a complex one, and sugar, which is a simple one. Should account for 45–65 percent of the energy of your diet. It provides 4 kcal / g.	Carbohydrate
6	Complex carbohydrate found in plants. Unlike other carbohydrates it passes through the body undigested and is healthy for the digestive system.	Fibre
7	It is a simple carbohydrate. Natural ones are found in foods such as milk, fruit, and vegetables. Added ones contribute calories and have no significant nutritional value.	Sugars
8	Found in a variety of foods such as meat, poultry, fish, legumes, nuts, milk products, and grain products. Builds muscles, bones, and teeth. Should account for 10–35 percent of the energy of your diet. It provides 4 kcal / g.	Protein
9	Found in many vegetables and fruit. Helps keep skin and eyesight healthy.	Vitamin A
10	Found in many vegetables and fruit. Helps the body fight infections.	Vitamin C
11	Found in milk and alternative foods. Builds strong bones and reduces the risk of osteoporosis (a disease where bones degenerate and become brittle).	Calcium
12	Found in foods such as meat, fish, poultry, grains, vegetables, fruit, nuts, and seeds. Helps the red blood cells carry oxygen throughout the body.	Iron

THIS PAGE INTENTIONALLY LEFT BLANK



## ENERGY EXPENDITURES FOR PHYSICAL ACTIVITY TABLE

Many references evaluate the amount of calories burnt during various activities. This table is a guide, understanding that other resources could suggest different values. Values below are for activities of a one-hour duration.

Activity (1 hour)	130 lbs	155 lbs	190 lbs
Aerobics, general	354	422	518
Aerobics, high impact	413	493	604
Aerobics, low impact	295	352	431
Archery (non-hunting)	207	246	302
Automobile repair	177	211	259
Backpacking, general	413	493	604
Badminton, competitive	413	493	604
Badminton, social, general	266	317	388
Basketball, game	472	563	690
Basketball, non-game, general	354	422	518
Basketball, officiating	413	493	604
Basketball, shooting baskets	266	317	388
Basketball, wheelchair	384	457	561
Bicycling, < 16 km / h, leisure	236	281	345
Bicycling, > 32 km / h, racing	944	1126	1380
Bicycling, 16–19 km / h, light effort	354	422	518
Bicycling, 19–22.4 km /h, moderate effort	472	563	690
Bicycling, 22.4–25.4 km / h, vigorous effort	590	704	863
Bicycling, 25.4–30.4 km / h, very fast, racing	708	844	1035
Bicycling, BMX or mountain	502	598	733
Bicycling, stationary, general	295	352	431
Bicycling, stationary, light effort	325	387	474
Bicycling, stationary, moderate effort	413	493	604
Bicycling, stationary, very light effort	177	211	259
Bicycling, stationary, very vigorous effort	738	880	1078
Bicycling, stationary, vigorous effort	620	739	906
Billiards	148	176	216
Bowling	177	211	259
Boxing, in ring, general	708	844	1035
Boxing, punching bag	354	422	518
Boxing, sparring	531	633	776
Broomball	413	493	604
Callisthenics (push ups, sit-ups), vigorous effort	472	563	690
Callisthenics, home, light/moderate effort	266	317	388
Canoeing, on camping trip	236	281	345
Canoeing, rowing, > 9.6 km / h, vigorous effort	708	844	1035
Canoeing, rowing, crewing, competition	708	844	1035
Canoeing, rowing, light effort	177	211	259
Canoeing, rowing, moderate effort	413	493	604
Carpentry, general	207	246	302
Carrying heavy loads, such as bricks	472	563	690
Child care: sitting / kneeling-dressing, feeding	177	211	259

A-CR-CCP-804/PF-001  
Attachment D to EO C404.01  
Instructional Guide

Child care: standing-dressing, feeding	207	246	302
Circuit training, general	472	563	690
Cleaning, heavy, vigorous effort	266	317	388
Cleaning, house, general	207	246	302
Cleaning, light, moderate effort	148	176	216
Coaching: football, soccer, basketball, etc	236	281	345
Construction, outside, remodelling	325	387	474
Cooking or food preparation	148	176	216
Cricket (batting, bowling)	295	352	431
Croquet	148	176	216
Curling	236	281	345
Dancing, aerobic, ballet or modern, twist	354	422	518
Dancing, ballroom, fast	325	387	474
Dancing, ballroom, slow	177	211	259
Dancing, general	266	317	388
Darts, wall or lawn	148	176	216
Diving, springboard or platform	177	211	259
Electrical work, plumbing	207	246	302
Farming, baling hay, cleaning barn	472	563	690
Farming, milking by hand	177	211	259
Farming, shovelling grain	325	387	474
Fencing	354	422	518
Fishing from boat, sitting	148	176	216
Fishing from river bank, standing	207	246	302
Fishing in stream, in waders	354	422	518
Fishing, general	236	281	345
Fishing, ice, sitting	118	141	173
Football or baseball, playing catch	148	176	216
Football, competitive	531	633	776
Football, touch, flag, general	472	563	690
Frisbee playing, general	177	211	259
Frisbee, ultimate	207	246	302
Gardening, general	295	352	431
Golf, carrying clubs	325	387	474
Golf, general	236	281	345
Golf, miniature or driving range	177	211	259
Golf, pulling clubs	295	352	431
Golf, using power cart	207	246	302
Gymnastics, general	236	281	345
Hacky sack	236	281	345
Handball, general	708	844	1035
Handball, team	472	563	690
Health club exercise, general	325	387	474
Hiking, cross country	354	422	518
Hockey, field	472	563	690
Hockey, ice	472	563	690
Horse grooming	354	422	518
Horse racing, galloping	472	563	690
Horseback riding, general	236	281	345
Horseback riding, trotting	384	457	561
Horseback riding, walking	148	176	216
Hunting, general	295	352	431

Jai alai	708	844	1035
Jogging, general	413	493	604
Judo, karate, kick boxing, tae kwon do	590	704	863
Kayaking	295	352	431
Kickball	413	493	604
Lacrosse	472	563	690
Marching band, playing instrument (walking)	236	281	345
Marching, rapidly, military	384	457	561
Moto-cross	236	281	345
Moving furniture, household	354	422	518
Moving household items, boxes, upstairs	531	633	776
Moving household items, carrying boxes	413	493	604
Mowing lawn, general	325	387	474
Mowing lawn, riding mower	148	176	216
Music playing, cello, flute, horn, woodwind	118	141	173
Music playing, drums	236	281	345
Music playing, guitar, classical, folk (sitting)	118	141	173
Music playing, guitar, rock / roll band (standing)	177	211	259
Music playing, piano, organ, violin, trumpet	148	176	216
Paddleboat	236	281	345
Painting, papering, plastering, scraping	266	317	388
Polo	472	563	690
Pushing or pulling stroller with child	148	176	216
Race walking	384	457	561
Racquetball, casual, general	413	493	604
Racquetball, competitive	590	704	863
Raking lawn	236	281	345
Rock climbing, ascending rock	649	774	949
Rock climbing, rappelling	472	563	690
Rope jumping, fast	708	844	1035
Rope jumping, moderate, general	590	704	863
Rope jumping, slow	472	563	690
Rowing, stationary, light effort	413	493	604
Rowing, stationary, moderate effort	502	598	733
Rowing, stationary, very vigorous effort	708	844	1035
Rowing, stationary, vigorous effort	561	669	819
Rugby	590	704	863
Running, 16 km / h	944	1126	1380
Running, 17.4 km / h	1062	1267	1553
Running, 8 km / h	472	563	690
Running, 8.3 km / h	531	633	776
Running, 9.6 km / h	590	704	863
Running, 10.7 km / h	649	774	949
Running, 11.2 km / h	679	809	992
Running, 12 km / h	738	880	1078
Running, 12.8 km / h	797	950	1165
Running, 13.8 km / h	826	985	1208
Running, 14.4 km / h	885	1056	1294
Running, cross country	531	633	776
Running, general	472	563	690
Running, in place	472	563	690
Running, on a track, team practice	590	704	863

A-CR-CCP-804/PF-001  
Attachment D to EO C404.01  
Instructional Guide

Running, stairs, up	885	1056	1294
Running, training, pushing wheelchair	472	563	690
Running, wheeling, general	177	211	259
Sailing, boat / board, windsurfing, general	177	211	259
Sailing, in competition	295	352	431
Scrubbing floors, on hands and knees	325	387	474
Shovelling snow, by hand	354	422	518
Shuffleboard, lawn bowling	177	211	259
Sitting-playing with child(ren)-light	148	176	216
Skateboarding	295	352	431
Skating, ice, 14.4 km / h or less	325	387	474
Skating, ice, general	413	493	604
Skating, ice, rapidly, > 14.4 km / h	531	633	776
Skating, ice, speed, competitive	885	1056	1294
Skating, roller	413	493	604
Ski jumping (climb up carrying skis)	413	493	604
Ski machine, general	561	669	819
Skiing, cross-country, > 12.8 km / h, racing	826	985	1208
Skiing, cross-country, moderate effort	472	563	690
Skiing, cross-country, slow or light effort	413	493	604
Skiing, cross-country, uphill, maximum effort	974	1161	1423
Skiing, cross-country, vigorous effort	531	633	776
Skiing, downhill, light effort	295	352	431
Skiing, downhill, moderate effort	354	422	518
Skiing, downhill, vigorous effort, racing	472	563	690
Skiing, snow, general	413	493	604
Skiing, water	354	422	518
Ski-mobiling, water	413	493	604
Skin diving, scuba diving, general	413	493	604
Sledding, tobogganing, bobsledding, luge	413	493	604
Snorkelling	295	352	431
Snow shoeing	472	563	690
Snowmobiling	207	246	302
Soccer, casual, general	413	493	604
Soccer, competitive	590	704	863
Softball or baseball, fast or slow pitch	295	352	431
Softball, officiating	354	422	518
Squash	708	844	1035
Stair-treadmill ergometer, general	354	422	518
Standing-packing / unpacking boxes	207	246	302
Stretching, hatha yoga	236	281	345
Surfing, body or board	177	211	259
Sweeping garage, sidewalk	236	281	345
Swimming laps, freestyle, fast, vigorous effort	590	704	863
Swimming laps, freestyle, light / moderate effort	472	563	690
Swimming, backstroke, general	472	563	690
Swimming, breaststroke, general	590	704	863
Swimming, butterfly, general	649	774	949
Swimming, leisurely, general	354	422	518
Swimming, sidestroke, general	472	563	690
Swimming, synchronized	472	563	690
Swimming, treading water, fast / vigorous	590	704	863

Swimming, treading water, moderate effort	236	281	345
Table tennis, ping pong	236	281	345
Tai chi	236	281	345
Teaching aerobics class	354	422	518
Tennis, doubles	354	422	518
Tennis, general	413	493	604
Tennis, singles	472	563	690
Unicycling	295	352	431
Volleyball, beach	472	563	690
Volleyball, competitive, in gymnasium	236	281	345
Volleyball, non-competitive; 6–9 member team	177	211	259
Walk / run-playing with child(ren)-moderate	236	281	345
Walk / run-playing with child(ren)-vigorous	295	352	431
Walking, 3.2 km / h, slow pace	148	176	216
Walking, 4.8 km / h, mod. pace, walking dog	207	246	302
Walking, 5.6 km / h, uphill	354	422	518
Walking, 6.4 km / h, very brisk pace	236	281	345
Walking, carrying infant or 15 pound load	207	246	302
Walking, grass track	295	352	431
Walking, upstairs	472	563	690
Walking, using crutches	236	281	345
Wallyball, general	413	493	604
Water aerobics, water callisthenics	236	281	345
Water polo	590	704	863
Water volleyball	177	211	259
Weight lifting or body building, vigorous effort	354	422	518
Weight lifting, light or moderate effort	177	211	259
White-water rafting, kayaking, or canoeing	295	352	431

Figure D-1 Energy Expenditures for Physical Activity Table

*Note.* From “NutriStrategy”, *Calories Burned During Exercise*, Copyright 2007 by NutriStrategy. Retrieved October 23, 2008, from <http://www.nutristrateg.com/activitylist4.htm>

THIS PAGE INTENTIONALLY LEFT BLANK

## ESTIMATED DAILY ENERGY REQUIREMENTS

### CALCULATE YOUR REE

Common formulas used to **approximate** your energy needs are the Harris-Benedict Equations. (Weight in kilograms, height in centimetres and age in years)

Male:  $REE = 66 + (13.75 \times \text{weight}) + (5 \times \text{height}) - (6.76 \times \text{age})$

Female:  $REE = 655 + (9.56 \times \text{weight}) + (1.85 \times \text{height}) - (4.68 \times \text{age})$

See the Resting Energy Expenditures Table handout located at Attachment F for additional help.

Your estimated REE: \_\_\_\_\_ kilocalories (commonly referred to as calories).

### CALCULATE THE THERMIC EFFECT OF FOOD

Take your REE and multiply it by 10 percent (which is equivalent to multiplying by 0.1).

$$\frac{\text{_____}}{\text{(REE)}} \times 0.1 = \text{_____ kcal}$$

### CALCULATE YOUR ENERGY REQUIREMENTS FOR DAILY ACTIVITIES

1. List your daily activities.
2. Using the Energy Expenditures for Physical Activity Table located at Attachment D, determine the hourly energy requirements for each activity.
3. Write how much time you spend doing each activity (1/2, 1, 2 or more hours).
4. Calculate the total energy requirements (multiply values in the hourly energy requirements column by values in the number of hours of activity column).
5. Add the values in the total energy requirements column to obtain the total energy requirements for daily activities.

Activity	Hourly energy requirements	Number of hours of activity	Total energy requirements
Total energy requirements for daily activities			

**Daily energy requirement** = REE + Thermic effect + Energy for activities

$$\text{_____} + \text{_____} + \text{_____} = \text{_____ kcal}$$

Determine number of servings required from Estimated Number of Servings table located at Attachment G.

THIS PAGE INTENTIONALLY LEFT BLANK



## RESTING ENERGY EXPENDITURES TABLE (in kcal)

This table does not include all possible body sizes. It should only be used as a guide to verify if the calculations are within the correct range.

<b>M a l e s</b>	<b>Weight (lbs) (kg)</b>	<b>105 47.7</b>	<b>110 50.0</b>	<b>115 52.3</b>	<b>120 54.5</b>	<b>125 56.8</b>	<b>130 59.1</b>	<b>135 61.4</b>	<b>140 63.6</b>	<b>150 68.2</b>	<b>160 72.7</b>	<b>170 77.3</b>	<b>180 81.8</b>	<b>190 86.4</b>	<b>200 90.9</b>	<b>210 95.5</b>	
	<b>Height (ft &amp; in) (cm)</b>	<b>5'0" 152.4</b>	<b>5'1" 154.9</b>	<b>5'2" 157.5</b>	<b>5'3" 160.0</b>	<b>5'4" 162.6</b>	<b>5'5" 165.1</b>	<b>5'6" 167.6</b>	<b>5'7" 170.2</b>	<b>5'8" 172.7</b>	<b>5'9" 175.3</b>	<b>5'10" 177.8</b>	<b>5'11" 180.3</b>	<b>6'0" 182.9</b>	<b>6'1" 185.4</b>	<b>6'2" 188.0</b>	
	<b>Age</b>																
	<b>14</b>	1390	1434	1478	1521	1565	1609	1653	1697	1742	1772	1848	1923	1998	2073	2148	2224
	<b>15</b>	1383	1427	1471	1515	1559	1603	1647	1691	1736	1766	1841	1916	1991	2067	2142	2217
<b>16</b>	1376	1420	1464	1508	1552	1596	1640	1684	1729	1759	1834	1909	1985	2060	2135	2210	
<b>17</b>	1369	1413	1457	1501	1545	1589	1633	1677	1722	1752	1827	1903	1978	2053	2128	2203	
<b>F e m a l e s</b>	<b>Weight (lbs) (kg)</b>	<b>90 40.9</b>	<b>95 43.2</b>	<b>100 45.5</b>	<b>105 47.7</b>	<b>110 50.0</b>	<b>115 52.3</b>	<b>120 54.5</b>	<b>125 56.8</b>	<b>130 59.1</b>	<b>140 63.6</b>	<b>150 68.2</b>	<b>160 72.7</b>	<b>170 77.3</b>	<b>180 81.8</b>	<b>190 86.4</b>	
	<b>Height (ft &amp; in) (cm)</b>	<b>4'10" 147.3</b>	<b>4'11" 149.9</b>	<b>5'0" 152.4</b>	<b>5'1" 154.9</b>	<b>5'2" 157.5</b>	<b>5'3" 160.0</b>	<b>5'4" 162.6</b>	<b>5'5" 165.1</b>	<b>5'6" 167.6</b>	<b>5'7" 170.2</b>	<b>5'8" 172.7</b>	<b>5'9" 175.3</b>	<b>5'10" 177.8</b>	<b>5'11" 180.3</b>	<b>6'0" 182.9</b>	
	<b>Age</b>																
	<b>14</b>	1253	1280	1306	1332	1359	1385	1412	1438	1465	1465	1513	1561	1609	1657	1705	1753
	<b>15</b>	1248	1275	1301	1328	1354	1381	1407	1433	1460	1460	1508	1556	1604	1652	1701	1749
<b>16</b>	1244	1270	1297	1323	1349	1376	1402	1429	1455	1455	1503	1551	1600	1648	1696	1744	
<b>17</b>	1239	1265	1292	1318	1345	1371	1398	1424	1450	1450	1499	1547	1595	1643	1691	1739	

Figure F-1 Resting Energy Expenditures Table

Note. Created by Director Cadets 3, 2008, Ottawa, ON: Department of National Defence.

THIS PAGE INTENTIONALLY LEFT BLANK

## ESTIMATED NUMBER OF SERVINGS

The following chart gives an estimate of the number of servings needed to meet the daily energy requirements.

Food Group	Daily Energy Requirements					
	1 500 kcal	2 000 kcal	2 500 kcal	3 000 kcal	3 500 kcal	4 000 kcal
	Number of Servings					
<b>Grain Products</b> (Minimum 5 servings)	5–6	7–9	9–11	11–13	13–15	15–17
<b>Vegetables and fruit</b> (Minimum 5 servings)	5–6	7–9	9–11	11–13	13–15	15–17
<b>Milk products</b> (Minimum 2 servings)	3	3	3	3–4	3–5	4–6
<b>Meat &amp; AlternativesL</b> (Minimum 2 servings)	2	2	2	2–3	2–4	3–4
<b>Other Foods</b>	Choose other foods in moderation after you have eaten enough from the four other food groups.			If you find it difficult to eat a large enough volume of food to meet your energy needs, try adding a little oil (olive, canola, soy, etc) or a few concentrated carbohydrates (juices, dried fruit, sweetened cereals or drinks)		
<p>If you are very physically active, add the number of servings from 2 columns. For example, if you need 4 500 kcal, use the servings for 3 000 kcal plus those from 1 500 kcal.</p> <p>If this is more food than you can comfortably eat or if you cannot maintain your body weight because you are training so much, try eating foods that have more energy and less volume. For example, juice or dried fruit rather than salad, 2 percent milk rather than skim milk, and / or nuts and seeds rather than beans.</p>						

Figure G-1 Estimated Number of Servings

*Note.* From *Top Fuel for Top Performance* (p. 20), by Department of National Defence, 2005, Ottawa, ON: Department of National Defence.

THIS PAGE INTENTIONALLY LEFT BLANK



**COMMON TRAINING  
PROFICIENCY LEVEL FOUR  
INSTRUCTIONAL GUIDE**



**SECTION 5**

**EO C404.02 – PREPARE TO CONDUCT THE CADET FITNESS ASSESSMENT**

Total Time:

60 min

**PREPARATION**

**PRE-LESSON INSTRUCTIONS**

Resources needed for the delivery of this lesson are listed in the lesson specification located in A-CR-CCP-804/PG-001, *Proficiency Level Four Qualification Standard and Plan*, Chapter 4. Specific uses for said resources are identified throughout the instructional guide within the TP for which they are required.

Review the lesson content and become familiar with the material prior to delivering the lesson.

Photocopy the enabling objective, lesson specification and instructional guide for EO M404.01 / M304.02 (Participate in the Cadet Fitness Assessment) and the Prepare to Conduct the Cadet Fitness Assessment handout located at Attachment A for each cadet.

Gather all equipment associated with the Cadet Fitness Assessment.

**PRE-LESSON ASSIGNMENT**

Nil.

**APPROACH**

An interactive lecture was chosen for TP 1 to present basic material on the components of the Cadet Fitness Assessment and to generate interest in the subject.

An in-class activity was chosen for TP 2 as it is an interactive way to provoke thought, stimulate interest and become familiar with the enabling objective, lesson specification and instructional guide for EO M404.01 / EO M304.02 (Participate in the Cadet Fitness Assessment).

**INTRODUCTION**

**REVIEW**

Nil.

**OBJECTIVES**

By the end of this lesson the cadet shall be prepared to conduct the Cadet Fitness Assessment.

## **IMPORTANCE**

It is important for the cadets to prepare to conduct the Cadet Fitness Assessment because they may be expected to conduct the assessment at the squadron. The Cadet Fitness Assessment will be conducted at least two times throughout the training year to track personal fitness levels. The information provided by the assessment will also help to create personal fitness goals, improve personal fitness and award Cadet Fitness Assessment Incentive Levels.

**Teaching Point 1****Describe the components of the Cadet Fitness Assessment.**

Time: 35 min

Method: Interactive Lecture



The cadets are familiar with the Cadet Fitness Assessment as they have participated in it a number of times. This TP provides a summary of the components of the Cadet Fitness Assessment to prepare the cadets to conduct the assessment.

**THE SEQUENCE FOR THE CADET FITNESS ASSESSMENT**

The Cadet Fitness Assessment is conducted with the cardiovascular component (20-m Shuttle Run Test) being completed first. The remaining components are set up as a circuit. The cadets complete the assessment with a partner who will track the scores.

**THE CARDIOVASCULAR COMPONENT****The 20-m Shuttle Run Test**

Describe and show the cadets how to set up the 20-m Shuttle Run Test. If time permits, allow the cadets to set up the 20-m Shuttle Run Test during this lesson.

**Objective of the 20-m Shuttle Run Test**

The 20-m Shuttle Run Test is progressive, in that it begins with an easy pace and gradually becomes more challenging as time passes. The 20-m Shuttle Run Test is an individual assessment and is based on a personal ability.

The 20-m Shuttle Run Test consists of running a distance of 20 m repeatedly, at a specified pace that increases each minute. Each cadet will be expected to run until they can no longer continue.

**Setting up the 20-m Shuttle Run Test**

Equipment required for the 20-m Shuttle Run Test includes:

- 20-m Shuttle Run Test CD,
- measuring tape,
- CD player, and
- pylons.

The 20-m Shuttle Run Test will be set up with two lines (pylons) a distance of 20 m apart. A number of 100–150 cm (40–60 inch) lanes will be created for the run (depending on the number of cadets), as illustrated in Figure 1. Ensure the CD player is close by and can be heard by all cadets.

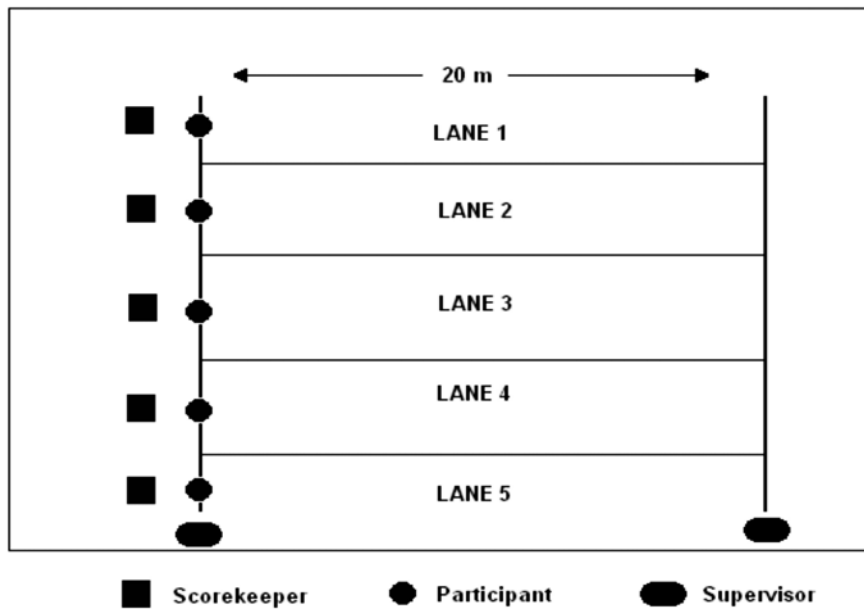

Figure 1 20-m Shuttle Run Test Layout

Note. Created by Director Cadets 3, 2007, Ottawa, ON: Department of National Defence.

### Conducting the 20-m Shuttle Run Test

1. Divide the cadets into pairs.
2. Distribute the *20-m Shuttle Run Test Individual Scoresheet B* and pens / pencils to one cadet in each pair.
3. Have the cadets with the scoresheet print their partner's name on the scoresheet and sit behind the starting line.
4. Have the cadets who are running the 20-m Shuttle Run Test line up in their respective lanes at the starting line and wait for instructions from the CD.
5. Play the CD. The scorekeeper will record the number of laps that are successfully completed on the scoresheet. The supervisors at each line will inform the scorekeeper when a cadet does not cross the line before the beep.
6. The 20-m Shuttle Run Test is complete when all the cadets have not reached the line before the beep for the second time.
7. Once completed, have the cadets who ran the 20-m Shuttle Run Test become the scorekeepers and the scorekeepers become the runners.
8. Repeat Steps 2–6.

### Scoring the 20-m Shuttle Run Test

The 20-m Shuttle Run Test will be scored using the *20-m Shuttle Run Test Individual Scoresheet B*, located at Attachment B to EO M404.01 / M304.02 (Participate in the Cadet Fitness Assessment) Instructional Guide. Each circle on the scoresheet represents a lap. When the cadet completes a lap they receive a check mark. If they are unsuccessful they receive an X (as illustrated in Figure 2). The cadet has completed the 20-m Shuttle Run Test when they are unable to successfully complete a lap a second time.



**FITNESSGRAM 20-m Shuttle Run Test Individual Score Sheet B**

Student Name Shepherd, John Class Alpha Date 13 July

✓	✓	✓	✓	✓	✗	✓	✓	✗
1	2	3	4	5	6	7	8	9
10	11	12	13	14	15	16	17	18
19	20	21	22	23	24	25	26	27
28	29	30	31	32	33	34	35	36
37	38	39	40	41	42	43	44	45
46	47	48	49	50	51	52	53	54

Figure 2 Sample Fitnessgram 20-m Shuttle Run Test Individual Scoresheet B

Note. From *Fitnessgram / Activitygram: Test Administration Manual* (3rd ed.) (p. 92), by The Cooper Institute, 2005, Windsor, ON: Human Kinetics. Copyright 2005 by The Cooper Institute.

**THE MUSCULAR STRENGTH COMPONENT****The Curl-Up**

Describe and show the cadets how to set up the curl-up. If time permits, allow the cadets to set up the curl-up station during this lesson.

**Objective of the Curl-Up**

The curl-up with knees bent and feet unanchored was chosen because it is a safe method for assessing abdominal strength and endurance.

This assessment is conducted by curling up repeatedly at a pace of one curl-up every three seconds until a second form correction is made (the first form correction does not count), the person can no longer continue, or has completed 75 curl-ups.

### Setting Up the Curl-Up

Equipment required for the curl-up includes:

- gym mat, and
- curl-up measuring strip.

Each curl-up station will be set up with a gym mat and a curl-up measuring strip.

### Conducting the Curl-Up

1. Have one cadet from each pair:
  - a. lay on their back with head down;
  - b. bend their knees at an angle of approximately 140 degrees;
  - c. place their feet flat and legs slightly apart; and
  - d. rest their palms on the mat with their arms straight, parallel to their trunk, and fingers stretched out (as illustrated in Figure 3).
2. The scorekeeper will place the measuring strip on the mat under the cadet's knees so their fingertips are resting on the nearest edge of the measuring strip (as illustrated in Figure 3).

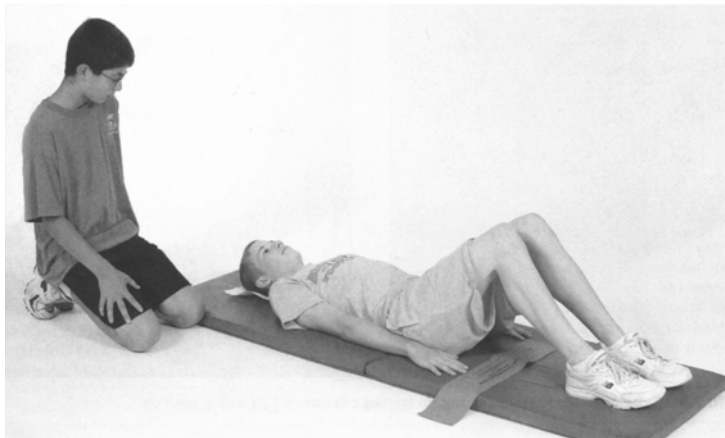

Figure 3 Curl-Up Starting Position

*Note.* From *Fitnessgram / Activitygram: Test Administration Manual* (3rd ed.) (p. 43), by The Cooper Institute, 2005, Windsor, ON: Human Kinetics. Copyright 2005 by The Cooper Institute.

3. The cadet on the mat will curl up (as illustrated in Figure 4), ensuring their fingers reach the other side of the measuring strip (as illustrated in Figure 5), repeatedly at a cadence of one curl every three seconds until a second form correction (the first form correction does not count) is made, they can no longer continue, or have completed 75 curl-ups.



Figure 4 Curl-Up

*Note.* From *Fitnessgram / Activitygram: Test Administration Manual* (3rd ed.) (p. 43), by The Cooper Institute, 2005, Windsor, ON: Human Kinetics. Copyright 2005 by The Cooper Institute.

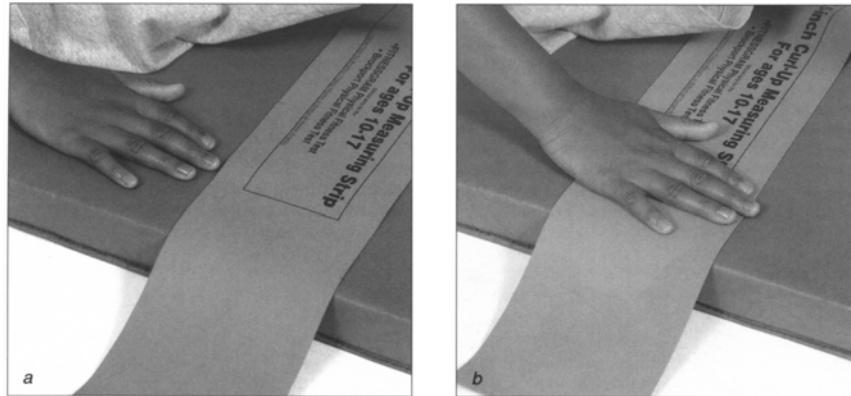

Figure 5 Curl-Up Finger Position

*Note.* From *Fitnessgram / Activitygram: Test Administration Manual* (3rd ed.) (p. 44), by The Cooper Institute, 2005, Windsor, ON: Human Kinetics. Copyright 2005 by The Cooper Institute.

4. The scorekeeper will count how many times the cadet can curl-up (which is the curl-up score).
5. Have the cadets switch positions and repeat Steps 1–4.

### Scoring the Curl-Up

Scoring for the curl-up is based on the number of curl-ups that are completed; until a second form correction (the first form correction does not count) is made, the cadet can no longer continue, or has completed 75 curl-ups.

### The Push-Up



Describe and show the cadets how to set up the push-up. If time permits, allow the cadets to set up the push-up station during this lesson.

## Objective of the Push-Up

The push-up from an elbow angle of 90 degrees is an assessment of upper body strength and endurance.

This assessment is conducted by pushing up repeatedly at a pace of one push-up every three seconds until a second form correction is made (the first form correction does not count) or the person can no longer continue.

## Conducting the Push-Up

1. Have one cadet from each pair:
  - a. lay face down;
  - b. place their hands under or slightly wider than their shoulders, with fingers stretched out;
  - c. straighten their legs with feet slightly apart; and
  - d. tuck their toes under the shins.
2. Have the cadet push up with their arms until they are straight, keeping the legs and back aligned (as illustrated in Figure 6).

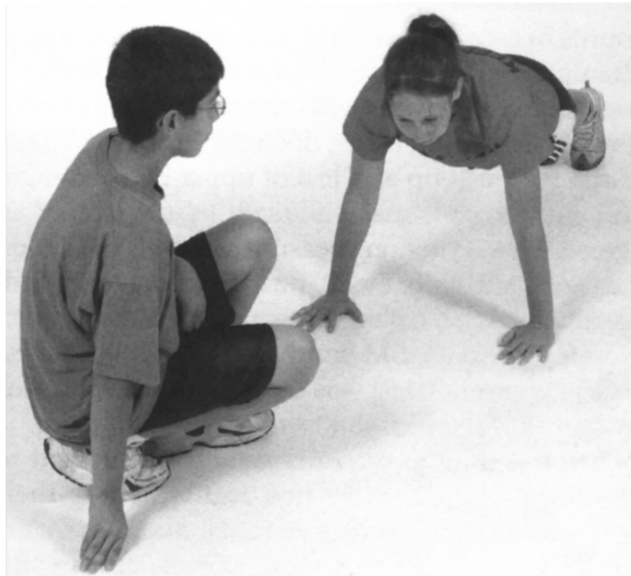

Figure 6 Push-Up Starting Position

*Note.* From *Fitnessgram / Activitygram: Test Administration Manual* (3rd ed.) (p. 48), by The Cooper Institute, 2005, Windsor, ON: Human Kinetics. Copyright 2005 by The Cooper Institute.

3. Have the cadet lower their body using their arms until the elbows bend at a 90-degree angle and the upper arms are parallel to the floor (as illustrated in Figure 7).



Figure 7 Down Position of the Push-Up

*Note.* From *Fitnessgram / Activitygram: Test Administration Manual* (3rd ed.) (p. 48), by The Cooper Institute, 2005, Windsor, ON: Human Kinetics. Copyright 2005 by The Cooper Institute.

4. Have the cadet repeat Steps 2 and 3 repeatedly at a cadence of one push-up every three seconds until a second form correction (the first form correction does not count) is made, or they can no longer continue.
5. The scorekeeper will count how many times the cadet can complete a push-up (which is the push-up score).
6. Have the cadets switch positions and repeat Steps 1–5.

### Scoring the Push-Up

Scoring for the push-up is based on the number of push-ups that are completed; until a second form correction (the first form correction does not count) is made, or the cadet can no longer continue.

## THE MUSCULAR FLEXIBILITY COMPONENT

### The Trunk Lift



Describe and show the cadets how to set up the trunk lift. If time permits, allow the cadets to set up the trunk lift station during this lesson.

### Objective of the Trunk Lift

The trunk lift is an assessment of trunk strength and flexibility.



It is important to discourage cadets from hyperextending their backs during this assessment.

This assessment is conducted by lying on the stomach and lifting the trunk to the highest comfortable position.

## Setting Up the Trunk Lift

Equipment required for the trunk lift includes:

- gym mat, and
- trunk lift measuring device.

Each trunk lift station will be set up with a gym mat and a trunk lift measuring device.

## Conducting the Trunk Lift

1. Have one cadet from each pair:
  - a. lay face down on the mat;
  - b. point their toes towards the end of the mat; and
  - c. place their hands under thighs (as illustrated in Figure 8).
2. Place a marker on the mat aligned with the cadet's eyes (as illustrated in Figure 8).



Figure 8 Starting Position for the Trunk Lift

*Note.* From *Fitnessgram / Activitygram: Test Administration Manual* (3rd ed.) (p. 46), by The Cooper Institute, 2005, Windsor, ON: Human Kinetics. Copyright 2005 by The Cooper Institute.

3. Have the cadet lift their upper body off the floor in a slow and controlled manner, to a maximum height of 30 cm (12 inches) (as illustrated in Figure 9). Ensure their head is aligned straight with the spine.

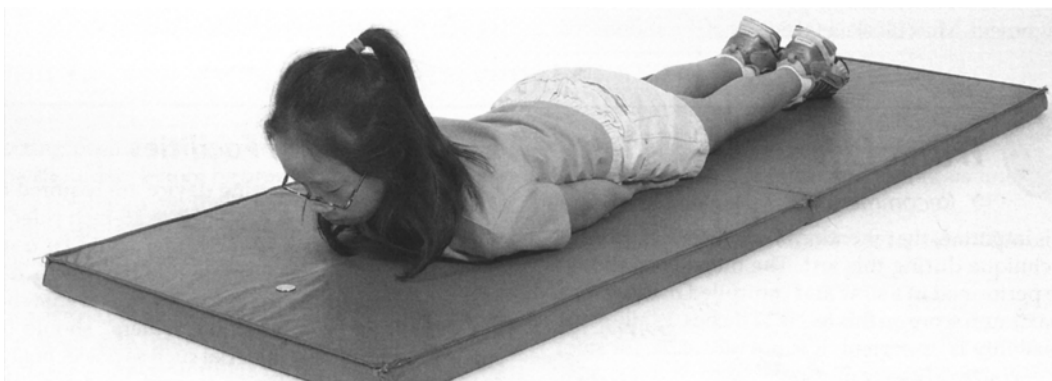

Figure 9 The Trunk Lift

*Note.* From *Fitnessgram / Activitygram: Test Administration Manual* (3rd ed.) (p. 46), by The Cooper Institute, 2005, Windsor, ON: Human Kinetics. Copyright 2005 by The Cooper Institute.

4. Have the cadet hold this position until the height can be measured (as illustrated in Figure 10).

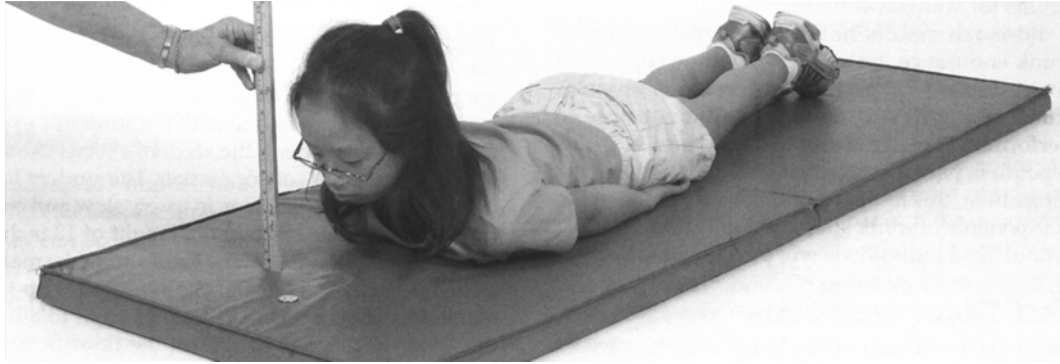

Figure 10 Measuring The Trunk Lift

*Note.* From *Fitnessgram / Activitygram: Test Administration Manual* (3rd ed.) (p. 46), by The Cooper Institute, 2005, Windsor, ON: Human Kinetics. Copyright 2005 by The Cooper Institute.

5. The scorekeeper will measure the distance, in inches, between the mat and the cadet's chin to determine the trunk lift score. The score will be a maximum of 12 inches to prevent hyperextension.
6. Have the cadets switch positions and repeat Steps 1–5.

### Scoring the Trunk Lift

Scoring for the trunk lift is based on the distance, in inches, between the mat and the chin, to a maximum of 12 inches.

### The Shoulder Stretch



Describe and show the cadets how to set up the shoulder stretch. If time permits, allow the cadets to set up the shoulder stretch station during this lesson.

### Objective of the Shoulder Stretch

The shoulder stretch is an assessment of upper arm and shoulder flexibility.

This assessment is conducted by reaching one arm over the shoulder on the same side, and the other arm behind the back to touch the fingertips.

### Setting Up the Shoulder Stretch

There is no equipment required for the shoulder stretch.

The shoulder stretch station should be large enough to accommodate the cadets.

### Conducting the Shoulder Stretch

1. Have one cadet from each pair test their right shoulder by:
  - a. reaching with the right hand over the right shoulder and down the back; and
  - b. reaching with the left hand behind the back to touch the right hand (as illustrated in Figure 11).

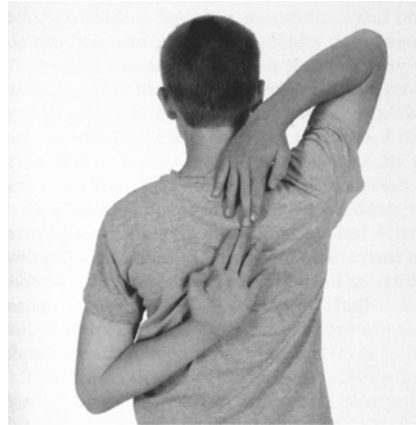

Figure 11 Right Shoulder Stretch

*Note.* From *Fitnessgram / Activitygram: Test Administration Manual* (3rd ed.) (p. 55), by The Cooper Institute, 2005, Windsor, ON: Human Kinetics. Copyright 2005 by The Cooper Institute.

2. The scorekeeper will observe if the hands are touching to determine the right shoulder stretch score (a yes or no).
3. Have the cadet test their left shoulder by:
  - a. reaching with the left hand over the left shoulder and down the back; and
  - b. reaching with the right hand behind the back to touch the left hand (as illustrated in Figure 12).

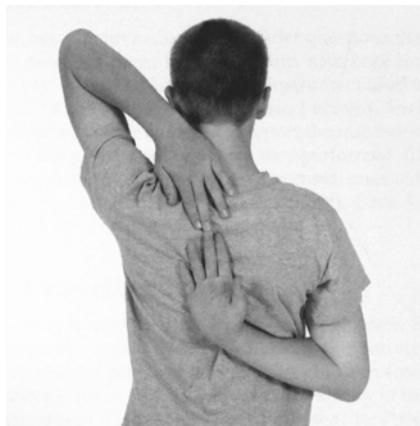

Figure 12 Left Shoulder Stretch

*Note.* From *Fitnessgram / Activitygram: Test Administration Manual* (3rd ed.) (p. 55), by The Cooper Institute, 2005, Windsor, ON: Human Kinetics. Copyright 2005 by The Cooper Institute.

4. The scorekeeper will observe if the hands are touching to determine the left shoulder stretch score.
5. Have the cadets switch positions and repeat Steps 1–4.

### **Scoring the Shoulder Stretch**

Scoring for the shoulder stretch is based on the cadet's ability to touch their fingers on both their right and left sides. The score is indicated with a yes (Y) or no (N) on the scoresheet.



## The Back-Saver Sit and Reach



Describe and show the cadets how to set up the back-saver sit and reach. If time permits, allow the cadets to set up the back-saver sit and reach station during this lesson.

### Objective of the Back-Saver Sit and Reach

The back-saver sit and reach assesses hamstring flexibility for each leg.

This assessment is conducted by placing the foot flat against the test apparatus, bending the other leg, and reaching forward with both hands. The same procedure is repeated for the other leg.

### Setting Up the Back-Saver Sit and Reach

The only piece of equipment required for the back-saver sit and reach is the test apparatus.

Ensure that there is a test apparatus for each group. Spread out each back-saver sit and reach station to allow enough room for the cadets and their scorekeepers.

### Conducting the Back-Saver Sit and Reach

1. Have one cadet from each pair remove their shoes.
2. Have the cadet:
  - a. sit in front of the test apparatus;
  - b. extend one leg fully with the foot flat against the face of the box;
  - c. bend the knee of the other leg with the sole of the foot flat on the floor;
  - d. ensure there is a 5- to 8-cm (2- to 3-inch) space between the knee on the straight leg, and the foot of the bent leg; and
  - e. extend their arms forward over the ruler with the hands placed on top of one another (as illustrated in Figure 13).



Figure 13 Starting Position for the Back-Saver Sit and Reach

*Note.* From *Fitnessgram / Activitygram: Test Administration Manual* (3rd ed.) (p. 54), by The Cooper Institute, 2005, Windsor, ON: Human Kinetics. Copyright 2005 by The Cooper Institute.

3. Have the cadet reach forward with both hands along the scale four times, holding the position on the fourth reach for at least one second (as illustrated in Figure 14).



Figure 14 The Back-Saver Sit and Reach

*Note.* From *Fitnessgram / Activitygram: Test Administration Manual* (3rd ed.) (p. 54), by The Cooper Institute, 2005, Windsor, ON: Human Kinetics. Copyright 2005 by The Cooper Institute.

4. The scorekeeper will measure the distance, in inches, that the cadet reached. This measurement will be the score for one leg, to a maximum of 12 inches to prevent hyperextension.
5. Have the cadet repeat Steps 1–3 for the other leg.
6. Have the cadets switch positions and repeat Steps 1–5.

### **Scoring the Back-Saver Sit and Reach**

Scoring for the back-saver sit and reach is based on the distance, in inches, that the cadet can reach with their hands for each leg, to a maximum of 12 inches.

---

## CONFIRMATION OF TEACHING POINT 1

### QUESTIONS:

- Q1. What scoresheet is used to score the 20-m Shuttle Run Test?
- Q2. How is the curl-up scored?
- Q3. What does the push-up assess?

### ANTICIPATED ANSWERS:

- A1. The 20-m Shuttle Run Test will be scored using the *20-m Shuttle Run Test Individual Scoresheet B*.
- A2. The curl-up is scored by counting the number of curl-ups completed.
- A3. The push-up assesses upper body strength and endurance.

---

## Teaching Point 2

**Conduct an activity where the cadets will become familiar with the enabling objective, lesson specification and instructional guide for EO M404.01 / M304.02 (Participate in the Cadet Fitness Assessment).**

Time: 15 min

Method: In-Class Activity

---

## ACTIVITY

### OBJECTIVE

The objective of this activity is to have the cadets become familiar with EO M404.01 / M304.02 (Participate in the Cadet Fitness Assessment) enabling objective, lesson specification and instructional guide.

### RESOURCES

- EO M404.01 / M304.02 (Participate in the Cadet Fitness Assessment) enabling objective, lesson specification and instructional guide,
- Prepare to Conduct the Cadet Fitness Assessment handout located at Attachment A, and
- Prepare to Conduct the Cadet Fitness Assessment answer key located at Attachment B.

### ACTIVITY LAYOUT

Nil.

### ACTIVITY INSTRUCTIONS

1. Distribute a copy of the enabling objective, lesson specification and instructional guide for EO M404.01 / M304.02 (Participate in the Cadet Fitness Assessment) and a Prepare to Conduct the Cadet Fitness Assessment handout located at Attachment A to each cadet.
2. Have the cadets read the documents and answer the questions on the handout.
3. Discuss the answers to the questions on the handout (answer key is located at Attachment B).

## **SAFETY**

Nil.

---

## **CONFIRMATION OF TEACHING POINT 2**

The cadets' participation in the activity will serve as the confirmation of this TP.

---

## **END OF LESSON CONFIRMATION**

The cadets' participation in the activities will serve as the confirmation of this lesson.

---

## **CONCLUSION**

---

## **HOMEWORK / READING / PRACTICE**

Nil.

## **METHOD OF EVALUATION**

Nil.

## **CLOSING STATEMENT**

This lesson provides background information on how to prepare to conduct the Cadet Fitness Assessment. This information will be helpful when conducting the Cadet Fitness Assessment at the squadron. Results from the Cadet Fitness Assessment are helpful in tracking personal fitness level, setting fitness goals, promoting lifelong fitness and for awarding Cadet Fitness Assessment Incentive Levels.

## **INSTRUCTOR NOTES / REMARKS**

This lesson should be conducted prior to EO M404.01 (Participate in the Cadet Fitness Assessment).

The cadets will be provided the opportunity to conduct the Cadet Fitness Assessment during EO M404.01 (Participate in the Cadet Fitness Assessment).

---

## **REFERENCES**

A0-204 CATO 14-18 D Cdts. (2010). *Cadet Fitness Assessment and Incentive Program*. Ottawa, ON: Department of National Defence.

C0-095 ISBN 0-7360-5962-8 The Cooper Institute. (n.d.). *Fitnessgram / activitygram test administration kit: Fitnessgram 8.0 stand-alone test kit*. Windsor, ON: Human Kinetics.

C0-167 ISBN 0-7360-5866-4 Meredith, M., & Welk, G. (Eds.). (2005). *Fitnessgram / activitygram: Test administration manual* (3rd ed.). Windsor, ON: Human Kinetics.

## PREPARE TO CONDUCT THE CADET FITNESS ASSESSMENT

Read EO M404.01 / M304.02's (Participate in the Cadet Fitness Assessment) enabling objective, lesson specification and instructional guide. Answer the following questions.

### ENABLING OBJECTIVE / LESSON SPECIFICATION

1. What are the cadets given to participate in the Cadet Fitness Assessment?

---

---

---

---

---

---

---

---

---

---

2. What method of instruction is used for this lesson? \_\_\_\_\_

### INSTRUCTIONAL GUIDE

3. What layout is used for the muscular strength and muscular flexibility components (stations)?

---

4. What is located at Attachment A? \_\_\_\_\_

5. What distance separates the two lines for the 20-m Shuttle Run Test? \_\_\_\_\_

6. Why was the curl-up chosen for the Cadet Fitness Assessment? \_\_\_\_\_

---

7. How is the push-up scored? \_\_\_\_\_

---

---

8. What equipment is required for the trunk lift?

---

---

## PREPARE TO CONDUCT THE CADET FITNESS ASSESSMENT ANSWER KEY

Read EO M404.01 / M304.02's (Participate in the Cadet Fitness Assessment) enabling objective, lesson specification and instructional guide. Answer the following questions.

### ENABLING OBJECTIVE / LESSON SPECIFICATION

1. What are the cadets given to participate in the Cadet Fitness Assessment?

***Cadet Fitness Assessment scoresheet,  
Pylons,  
Measuring tape,  
Gym mats,  
CD player,  
30-cm (12-inch) ruler,  
Small cardboard box, and  
Supervision.***

2. What method of instruction is used for this lesson? ***A practical activity.***

### INSTRUCTIONAL GUIDE

3. What layout is used for the muscular strength and muscular flexibility components (stations)?

***A circuit.***

4. What information is located at Attachment A? ***Cadet Fitness Assessment Scoresheet.***

5. What distance separates the two lines for the 20-m Shuttle Run Test? ***20 m.***

6. Why was the curl-up chosen for the Cadet Fitness Assessment? ***The curl-up was chosen because it is a safe method for assessing abdominal strength and endurance.***

7. How is the push-up scored? ***Scoring for the push-up is based on the number of push-ups that are completed, until a second form correction is made or the participant can no***

8. What equipment is required for the trunk lift?

***Gym mat, and  
Trunk lift measuring device.***

THIS PAGE INTENTIONALLY LEFT BLANK