



ROYAL CANADIAN AIR CADETS
PROFICIENCY LEVEL FOUR
INSTRUCTIONAL GUIDE



SECTION 1

EO C470.01 – DISCUSS AIRCRAFT MANUFACTURERS

Total Time:	30 min
-------------	--------

PREPARATION

PRE-LESSON INSTRUCTIONS

Resources needed for the delivery of this lesson are listed in the lesson specification located in A-CR-CCP-804/PG-001, *Proficiency Level Four Qualification Standard and Plan*, Chapter 4. Specific uses for said resources are identified throughout the instructional guide within the TP for which they are required.

Review the lesson content and become familiar with the material prior to delivering the lesson.

Prepare the list of international partnerships located at Attachment A by photocopying the list and cutting the sections apart to distribute to the cadets.

Photocopy the International Partnership Summary Sheet located at Attachment B for each cadet.

Photocopy the Unmanned Aerial Vehicle (UAV) Manufacturers Worksheet located at Attachment C for each cadet.

UAVs are continuously changing. The information presented in Reference C3-324 may be used as a starting point in researching current UAVs and UAV manufacturers. Research current UAVs and UAV manufacturers and collect information on two or three UAVs from newspapers, magazines, journals or websites to present in TP 2. The *Aircraft* page on the Air Force website (<http://www.airforce.gc.ca>) may include information on UAVs used by the Canadian Forces.

PRE-LESSON ASSIGNMENT

At least one week before the lesson, assign each cadet (or have each cadet select) an international partnership from the list of international partnerships located at Attachment A. Distribute an International Partnership Summary Sheet located at Attachment B to each cadet. Have the cadets review and research the international partnership details and prepare a short oral presentation (approximately 2–5 minutes) using the International Partnership Summary Sheet located at Attachment B.

APPROACH

An in-class activity was chosen for TP 1 as it is an interactive way to provoke thought and stimulate interest among cadets.

An interactive lecture was chosen for TP 2 to identify UAV manufacturers.

INTRODUCTION

REVIEW

Nil.

OBJECTIVES

By the end of this lesson the cadet shall have discussed international partnerships between aircraft manufacturers and identified UAV manufacturers.

IMPORTANCE

It is important for cadets to discuss international partnerships between aircraft manufacturers as Canada is a leading exporter of advanced technology and is the fourth largest producer of civil aircraft in the world. It is important for cadets to identify UAV manufacturers as UAVs are a relatively new technology and are rapidly becoming more important in aviation, especially military aviation.

Teaching Point 1

Conduct an activity where the cadets will review a summary of an international partnership between aircraft manufacturers and make a short oral presentation on the international partnership.

Time: 20 min

Method: In-Class Activity

ACTIVITY**OBJECTIVE**

The objective of this activity is have the cadets review a summary of an international partnership between aircraft manufacturers and make a short oral presentation on the international partnership.

RESOURCES

- Pen / pencil,
- List of international partnerships located at Attachment A, and
- International Partnership Summary Sheet located at Attachment B.

ACTIVITY LAYOUT

Nil.

ACTIVITY INSTRUCTIONS

Have each cadet make a short oral presentation (approximately 2–5 minutes) to the group on their selected / assigned international partnership using the information they have recorded on the International Partnership Summary Sheet.



If there is not enough time for all the cadets to make their presentations, the cadets can be divided into two or more groups.

SAFETY

Nil.

CONFIRMATION OF TEACHING POINT 1

The cadets' participation in the activity will serve as the confirmation of this TP.

Teaching Point 2

Identify UAV manufacturers.

Time: 5 min

Method: Interactive Lecture



Distribute an Unmanned Aerial Vehicles (UAV) Manufacturers Worksheet located at Attachment C to each cadet.



Present the information collected on the UAVs to the cadets and have the cadets make notes using the Unmanned Aerial Vehicles (UAV) Manufacturers Worksheet.

CONFIRMATION OF TEACHING POINT 2

The cadets' completion of the Unmanned Aerial Vehicles (UAV) Manufacturers Worksheet will serve as the confirmation of this TP.

END OF LESSON CONFIRMATION

The cadets' participation in presenting the information on an international manufacturing partnership will serve as the confirmation of this lesson.

CONCLUSION

HOMEWORK / READING / PRACTICE

Nil.

METHOD OF EVALUATION

Nil.

CLOSING STATEMENT

Canada is one of the world's leading suppliers of aviation technology. International partnerships between Canadian aviation manufacturers and those in other countries results in 85 percent of the aviation production being sold internationally. The use of UAVs, especially in military aviation, is growing rapidly and the manufacturing of UAVs is becoming an important sector in aviation manufacturing.

INSTRUCTOR NOTES / REMARKS

Cadets who are qualified Advanced Aviation Technology – Aircraft Manufacturing and Maintenance may be able to assist with this lesson.

REFERENCES

- C3-321 ISBN 978-2-921393-91-1 Bombardier Inc. (2009). *Canada's Bombardier*. Canada: Bombardier Inc.
- C3-322 Government of Canada. (2008). *Canada's aerospace advantages*. Retrieved February 10, 2009 from <http://investincanada.gc.ca/eng/industry-sectors/advanced-manufacturing/aerospace/aerospace-advantages.aspx>
- C3-323 Industry Canada. (2009). *Aerospace in Canada*. Retrieved February 10, 2009 from <http://www.ic.gc.ca/eic/site/ad-ad.nsf/eng/ad03909.html>
- C3-324 Thirty Thousand Feet Aviation Directory. (2009). *Unmanned aerial vehicles*. Retrieved February 10, 2009, from <http://www.thirtythousandfeet.com/uav.htm>

THIS PAGE INTENTIONALLY LEFT BLANK

International Partnerships

After photocopying, cut the list apart on the dotted lines and distribute as required to the cadets.

Pratt & Whitney Canada

- Pratt & Whitney Canada is an aerospace leader committed to shaping the future of business, general aviation, and regional aircraft and helicopters with high-performing, dependable engines.
 - A new 10 000-pound thrust class engine family was selected by Cessna Aircraft for the Citation Columbus business jet and will exceed International Civil Aviation Organization (ICAO) emissions standards by up to 50 percent.
-

Bombardier Aerospace

- Bombardier's regional airliner product family includes the CRJ series regional jets and the Q series turboprop.
 - Bombardier is the world's third largest civil aircraft manufacturer with locations in 22 countries and customers in more than 100 countries.
-

Goodrich and Messier-Dowty

- The landing gear market is the undisputed domain of Canadian industry.
 - Goodrich is the chosen supplier of components for the Airbus A380 landing gear. Messier-Dowty supplies landing gear for the Boeing 787.
-

ExelTech Aerospace

- ExelTech Aerospace is the largest regional aircraft maintenance, repair, and overhaul (MRO) in North America and services such types as the Bombardier CRJ, Embraer ERJ, ATR-42, ATR-72, Boeing 737, and Saab 340.

Magellan, Honeywell, and Avcorp

- The Joint Strike Fighter (JSF) program has nine different nations as partners: the United States, the United Kingdom, Italy, the Netherlands, Turkey, Canada, Denmark, Norway, and Australia.
 - Several Canadian companies supply components and systems to the JSF including Magellan (primary flight and propulsion structures), Honeywell (power management system), and Avcorp (outboard wings).
-

CAE

- CAE is a world leader in simulation and training services for civil and military aviation.
- Through its global network of 27 civil and military aviation training centres, CAE trains more than 75 000 crew members annually.

Thales

- Thales is a world leader in mission-critical information systems for aviation, defence, and security markets with operations in 50 countries.
- Their headquarters is in Montreal and it is the worldwide centre of excellence for flight control systems.

CMC Electronics

- CMC Electronics provides innovative cockpit systems integration and avionics to customers worldwide.
- CMC is the prime contractor for the avionics systems integration of the Beechcraft T-6B military trainer aircraft.

Magellan Aerospace Corporation

- Magellan Aerospace Corporation has locations in Canada, the United States, the United Kingdom, and India.
- Magellan designs, manufactures, and repairs aeroengine and aerostructure components and assemblies.

Avcorp

- Avcorp produces high-strength interior panels, fuel tanks, structural wing components, and fully integrated vertical and horizontal stabilizers.
- Avcorp is providing primary flight structures for the Cessna Sovereign and Citation CJ3 business jets.

Standard Aero

- Standard Aero is among the largest small-turbine engine maintenance and repair companies in the world, providing MRO services for General Electric, Rolls-Royce, Honeywell and P&WC engines.
-

International Partnership Summary Sheet

Companies and Countries Involved
Aircraft Types and / or Components Involved
Additional Information

THIS PAGE INTENTIONALLY LEFT BLANK

Unmanned Aerial Vehicle (UAV) Manufacturers Worksheet

UAV Name	Manufacturer Name and Country of Manufacture	Purpose(s)

THIS PAGE INTENTIONALLY LEFT BLANK



ROYAL CANADIAN AIR CADETS
PROFICIENCY LEVEL FOUR
INSTRUCTIONAL GUIDE



SECTION 2

EO C470.02 – DISCUSS AIRCRAFT ASSEMBLY

Total Time: 30 min

PREPARATION

PRE-LESSON INSTRUCTIONS

Resources needed for the delivery of this lesson are listed in the lesson specification located in A-CR-CCP-804/PG-001, *Proficiency Level Four Qualification Standard and Plan*, Chapter 4. Specific uses for said resources are identified throughout the instructional guide within the TP for which they are required.

Review the lesson content and become familiar with the material prior to delivering the lesson.

Create slides of the Figures located at Attachments A and B.

Cue *The World's Biggest Airliner: The Airbus A380* DVD to the first chapter, *Toulouse, France* (seven minutes).

PRE-LESSON ASSIGNMENT

Nil.

APPROACH

An interactive lecture was chosen for this lesson to introduce aspects of aircraft assembly methods and give an overview of them.

INTRODUCTION

REVIEW

Nil.

OBJECTIVES

By the end of this lesson the cadet shall have discussed the assembly of aircraft components in a manufacturing setting.

IMPORTANCE

It is important for the cadets to learn about aircraft assembly methods because this will enhance their understanding of aircraft and the field of aviation.

Teaching Point 1**Describe different methods of assembly of components.**

Time: 15 min

Method: Interactive Lecture

SMALL MANUFACTURERS

For an aircraft to fly correctly, the main structural components, such as fuselage, wings, engines and empennage parts must be aligned perfectly. Any deviation or flaw, such as a twist in any component, will impair flight and have a negative effect on flight controls. Cranes hold the heavy parts in place, jigs and templates position them precisely. The development of techniques for measuring and positioning components on the structure to a high degree of accuracy have been developed, as aircraft have become heavier and faster.

LARGE MANUFACTURERS

Some aircraft are now so large that cranes cannot lift and hold the parts satisfactorily. Special carriers are custom-built to hold the parts, while computer control is used to bring them together. Lasers measure distances and angles with the use of mirrors, and send the data to high-speed computers. By using these methods, the fuselage, wings and empennage components can be assembled precisely, no matter how large they are.

Not all aircraft components are structural. A company such as Bombardier Aerospace has hundreds of suppliers that provide everything from horizontal stabilizers to airspeed indicators. All of these components fit and work together as a result of a process called Systems Integration. The aerospace engineers designing the aircraft must ensure that physical components and associated software programs work together.



Show the cadets the first chapter *Toulouse France* of *The World's Biggest Airliner: The Airbus A380*. This section covers the use of mirrors and an infrared laser positioning system and shows the fuselage components being joined.

CONFIRMATION OF TEACHING POINT 1**QUESTIONS:**

- Q1. Why must an aircraft's structural components be aligned perfectly?
- Q2. For large aircraft, what type of control is used to bring the structural parts together?
- Q3. What is the name of the process that aeronautical engineers use to integrate separate systems?

ANTICIPATED ANSWERS:

- A1. Any deviation or flaw will impair flight and have a negative effect on flight controls.
- A2. Computer control.
- A3. Systems Integration.

Teaching Point 2**Discuss manufacturers' assembly areas.**

Time: 10 min

Method: Interactive Lecture

A SMALL MANUFACTURER'S SHOP

Small manufacturers can often perform all necessary operations in one location like Viking Air, which manufactures the new 400 series Twin Otter and remanufactures Beaver and Otter aircraft near the Victoria International Airport in Sydney, British Columbia. A small manufacturer's shop is characterized by all the aircraft parts and materials coming together at one manufacturing plant prior to final assembly. All necessary machinery and facilities are provided, sometimes under one roof. Manufacturing encompasses all phases of assembly from sheet metal bending, engine assembly, avionics and final painting and interior finish.



Viking Air is considered a small manufacturer's shop. They manufacture, assemble, modify, and repair aircraft.

A LARGE MANUFACTURER'S ASSEMBLY LINE

All manufacturers need machines to move large, heavy components such as wings and to control their motion with precision. In the assembly areas of large aircraft, these machines are also large.



Show the cadets the series of assembly area photographs located at Attachment A.



Larger manufacturers generally have more career specialization than smaller ones, such as engine, airframe or avionics specialization. Small manufacturers have fewer employees, so they need their employees to be able to handle more related fields.

Large manufacturers such as Bombardier Aerospace have facilities around the world. The materials and components for the basic aircraft structure are gathered at one assembly plant, such as Downsview in Toronto, Ontario. This plant is responsible for the final assembly of structural components for the Learjet 45 aircraft, the Q-Series turboprops and the Global family of business aircraft. The facility occupies 324 acres of land and has almost two million square feet of building floor space. At Dorval, Quebec, Bombardier has a completion facility with 31 345 square metres (337 400 square feet), housing up to 14 Global Express aircraft and a delivery centre in which customers can choose design options in a virtual reality environment. The finishing touches, such as cabin furnishings, are installed here. A separate 7 246 square metre (78 000 square foot) paint and strip shop is located next to the completion centre, capable of housing up to four aircraft at a time.

Another 38 591 square metre (415 400 square foot) facility is located in Dorval, near the Bombardier Aerospace administrative centre and the Canadair aircraft assembly plant.

Airbus has an even larger operation. The A380 is assembled and delivered in Europe and has major structural components made in Australia, Canada, England, Finland, France, Germany, Italy, Malaysia, Mexico, Morocco, Russia, Spain, Turkey and the USA.

Suppliers, for both structural and minor components, are located around the world:

Australia	Wingtip fences	Mexico	Very large size special Hi-Lite® pull-in bolts
Canada	Pratt & Whitney Canada: Auxiliary power unit; and Goodrich: Body and wing landing gear	Morocco	Ducts for the air distribution system
England	Wings	Russia	Materials—titanium, aluminum, magnesium alloys and steel
Finland	Lift spoilers	Spain	Lateral boxes of the horizontal tail plane, the main landing gear doors, sections of the rear fuselage of the aircraft and the vertical stabilizer
France	France is the centre of A380 production	Sweden	Fixed leading edge from inner engine installation to wing tip. This includes wing spar, rib assemblies, system installation brackets and both inner and outer pylon fixed structures
Germany	Fuselage fabrication / assembly, aircraft finishing, waste water systems	Turkey	Large size special Hi-Lite® pull-in bolts of up to 28.5 mm (one inch) diameter, in both titanium and high-strength alloys, for the assembly of the most critical high-fatigue structural areas like wing spars, centre wing box and wing-to-fuselage junction
Italy	Central fuselage	USA	Airbus has an engineering design centre in Wichita, Kansas and many suppliers in the USA
Malaysia	Fixed leading edge lower panels and inboard outer fixed leading edge of wings	These are only the main supplier relationships that Airbus has developed around the world.	

Figure 1 Airbus A380 World-Wide Suppliers

Note. Created by Director Cadets 3, 2009, Ottawa, ON: Department of National Defence.



Show the cadets Figures B-1 to B-6 located at Attachment B. These pictures indicate the significance of the pylon fixed structures and pylon brackets that mount the four engines to the A380 wing. Each engine develops 31 750 kg (70 000 lbs) of thrust against the titanium pylons which transfer the thrust to the aircraft's wing.



Show the cadets Figure B-7 located at Attachment B, which lists Airbus A380 suppliers in North America.



For more information about how an A380 is made, the cadets can visit the Airbus Navigator at web page <http://events.airbus.com/A380/Default2.aspx?ArtId=644> or visit the Airbus website at www.airbus.com.

CONFIRMATION OF TEACHING POINT 2**QUESTIONS:**

- Q1. What characterizes a small manufacturer's shop?
- Q2. Where are large manufacturers located?
- Q3. What happens at a large manufacturer's completion facility?

ANTICIPATED ANSWERS:

- A1. All the aircraft parts and materials come together at one place prior to final assembly.
- A2. Around the world.
- A3. The finishing touches, such as cabin furnishings, are installed.

END OF LESSON CONFIRMATION**QUESTIONS:**

- Q1. Why must an aircraft's structural components be aligned perfectly?
- Q2. What happens at a large manufacturer's completion facility?
- Q3. What is different with respect to career specialization between large and small manufacturers?

ANTICIPATED ANSWERS:

- A1. Any deviation or flaw will impair flight and have a negative effect upon flight controls.
- A2. The finishing touches, such as cabin furnishings, are installed.
- A3. Larger manufacturers generally have more career specialization than smaller ones.

CONCLUSION

HOMEWORK / READING / PRACTICE

Nil.

METHOD OF EVALUATION

Nil.

CLOSING STATEMENT

Precise assembly of large structures is a difficult yet critically important aspect of aircraft manufacturing, which benefits from continued development and improved techniques.

INSTRUCTOR NOTES / REMARKS

The cadets may have previously viewed The World's Biggest Airliner: The Airbus A380 if EO C270.04 was selected in Proficiency Level Two. This lesson focuses and expands on the assembly of aircraft.

Cadets who are qualified Advanced Aviation Technology – Aircraft Manufacturing and Maintenance may be able to assist with this lesson.

REFERENCES

C3-105 Brisley, T., & Pascaud, S. (Executive Producer), & Bowie, B. (Writer / Director) (2003). *World's biggest airliner: The Airbus A380* [Motion Picture]. United States: The Learning Channel.

C3-136 ISBN 0-88487-207-6 Sanderson Training Systems. (2001). *A&P technician airframe textbook*. Englewood, CO: Jeppesen Sanderson Inc.



Figure A-1 Rebuilding a C-130 Centre Wing

Note. From "L3 Communications Limited", 2007, *SPAR Aerospace: Globally Competitive Aerospace Solutions*. Retrieved October 23, 2007, from <http://www.spar.ca/>



Figure A-2 Placing a C-130 Centre Wing

Note. From "L3 Communications Limited", 2007, *SPAR Aerospace: Globally Competitive Aerospace Solutions*. Retrieved October 23, 2007, from <http://www.spar.ca/>



Figure A-3 Positioning a C-130 Centre Wing

Note. From "L3 Communications Limited", 2007, *SPAR Aerospace: Globally Competitive Aerospace Solutions*. Retrieved October 23, 2007, from <http://www.spar.ca/>



Figure A-4 Bombardier QR 400 Fuselage Assembly

Note. From "Media Centre", by Bombardier Aerospace, 2007, *QR 400 Assembly*. Retrieved November 1, 2007, from http://www.bombardier.com/MediaCenter/Multimedia?action=view&gid=3_0&cid=295&page=1&Language=en



Figure A-5 Bombardier QR 400 Wing Assembly

Note. From "Media Centre", by Bombardier Aerospace, 2007, *QR 400 Assembly*. Retrieved November 1, 2007, from http://www.bombardier.com/MediaCenter/Multimedia?action=view&gid=3_0&cid=295&page=1&Language=en



Figure A-6 Bombardier QR 400 Assembly Line

Note. From "Media Centre", by Bombardier Aerospace, 2007, *QR 400 Assembly*. Retrieved November 1, 2007, from http://www.bombardier.com/MediaCenter/Multimedia?action=view&gid=3_0&cid=295&page=1&Language=en



Figure A-7 Bombardier QR 400 Assembly Activity

Note. From "Media Centre", by Bombardier Aerospace, 2007, *QR 400 Assembly*. Retrieved November 1, 2007, from http://www.bombardier.com/MediaCenter/Multimedia?action=view&gid=3_0&cid=295&page=1&Language=en



Figure A-8 Bombardier QR 400 Engine Assembly

Note. From "Media Centre", by Bombardier Aerospace, 2007, *QR 400 Assembly*. Retrieved November 1, 2007, from http://www.bombardier.com/MediaCenter/Multimedia?action=view&gid=3_0&cid=295&page=1&Language=en



Figure A-9 Bombardier CRJ700 Fuselage Assembly

Note. From "Media Centre", by Bombardier Aerospace, 2007, *CRJ700 Assembly*. Retrieved November 1, 2007, from http://www.bombardier.com/MediaCenter/Multimedia?action=view&gid=3_0&cid=295&page=1&Language=en



Figure A-10 Bombardier CRJ700 Assembly Line

Note. From "Media Centre", by Bombardier Aerospace, 2007, *CRJ700 Assembly*. Retrieved November 1, 2007, from http://www.bombardier.com/MediaCenter/Multimedia?action=view&gid=3_0&cid=295&page=1&Language=en



Figure A-11 Bombardier CRJ700 Assembly

Note. From "Media Centre", by Bombardier Aerospace, 2007, *CRJ700 Assembly*. Retrieved November 1, 2007, from http://www.bombardier.com/MediaCenter/Multimedia?action=view&gid=3_0&cid=295&page=1&Language=en



Figure A-12 A Q400 Fuselage Arrives from MHI, Japan

Note. From "Media Centre", by Bombardier Aerospace, 2007, *QR 400 Assembly*. Retrieved November 1, 2007, from http://www.bombardier.com/MediaCenter/Multimedia?action=view&gid=3_0&cid=295&page=1&Language=en



Figure B-1 Building a Pylon

Note. From "A380 Navigator", by Airbus, 2007, *Manufacturing Process*. Retrieved November 24, 2007, from <http://events.airbus.com/A380/Default2.aspx?ArtId=644>



Figure B-2 Pylon Ready to Go

Note. From "A380 Navigator", by Airbus, 2007, *Manufacturing Process*. Retrieved November 24, 2007, from <http://events.airbus.com/A380/Default2.aspx?ArtId=644>

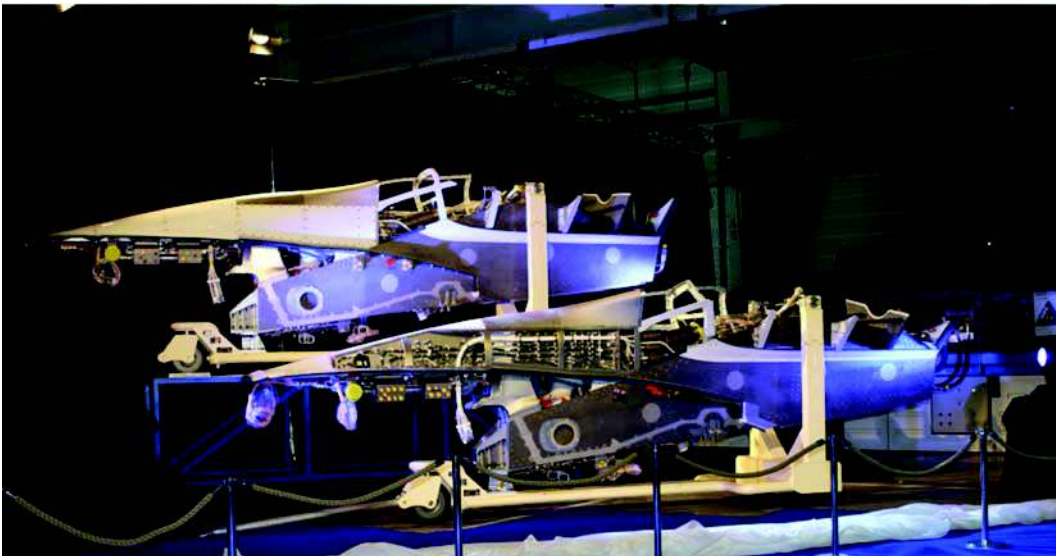

Figure B-3 Pylon on Display

Note. From "A380 Navigator", by Airbus, 2007, *Manufacturing Process*. Retrieved November 24, 2007, from <http://events.airbus.com/A380/Default2.aspx?ArtId=644>



Figure B-4 Empty Pylons

Note. From "A380 Navigator", by Airbus, 2007, *Manufacturing Process*. Retrieved November 24, 2007, from <http://events.airbus.com/A380/Default2.aspx?ArtId=644>



Figure B-5 Engines on Pylons

Note. From "A380 Navigator", by Airbus, 2007, *Manufacturing Process*. Retrieved November 24, 2007, from <http://events.airbus.com/A380/Default2.aspx?ArtId=644>



Figure B-6 A380 with Engines

Note. From "A380 Navigator", by Airbus, 2007, *Manufacturing Process*. Retrieved November 24, 2007, from <http://events.airbus.com/A380/Default2.aspx?ArtId=644>



Figure B-7 Pylons at Work

Note. From "A380 Navigator", by Airbus, 2007, *Manufacturing Process*. Retrieved November 24, 2007, from <http://events.airbus.com/A380/Default2.aspx?ArtId=644>

L-3 COMMUNICATIONS AVIATION RECORDERS

L-3 Communications Aviation Recorders (L-3AR) provides the flight data recorder and cockpit voice recorder for the A380.

ROCKWELL COLLINS

Rockwell Collins' suite of communication and navigation sensors provides the baseline for the A380.

ALCOA

Alcoa supplies forgings, extrusions, sheet, plate, and castings for the A380's wing and fuselage skins, stringers, frames, spars, gear ribs, engine and pylon support, seat tracks and floor beams.

C&D AEROSPACE

California-based C&D Aerospace provides aircraft interior systems for the A380.

CYTEC - ENGINEERED MATERIALS

Cytec Engineered Materials produces composites, adhesives and carbon fibres.

EATON CORPORATION

US-based Eaton Corporation supplies the A380 with a highly-advanced higher-pressure hydraulic fluid power generation system, the world's first 5000-psi pump for a commercial aircraft.

HONEYWELL AEROSPACE

Honeywell Aerospace will deliver 12 products and systems for the A380.

M.C.GILL CORPORATION

M.C. Gill Corporation provides fully equipped composite floor panels for the cockpit of the A380, the main electronics bay situated below the cockpit and the emergency electronics bay, which sits forward of the upper deck passenger cabin.

MEGGITT SAFETY SYSTEMS

Meggitt Safety Systems Inc.(MSSI) supplies the fire detection systems for the A380's engines, auxiliary power units (APUs) and main landing gears.

MONOGRAM SYSTEMS

Monogram Systems, a unit of Zodiac's airline equipment branch in California, supplies an advanced water and vacuum waste system for the A380 that will incorporate state-of-the-art technical innovations.

NORTHROP GRUMMAN

The navigation systems division of US defence company Northrop Grumman supplies the A380 with its LTN-101E global navigation air data inertial reference unit.

PARKER

Parker Aerospace, a business unit of the Parker Hannifin Corporation, is participating in several work packages for the A380.

RALEE

Ralee Engineering Company, a Triumph Group company based in California, supplies the wing top skin stringers (the metal structure that goes under the wing panels) for the A380.

Figure B-8 Airbus A380 North American Suppliers

Note. Created by Director Cadets 3, 2007, Ottawa, ON: Department of National Defence.

THIS PAGE INTENTIONALLY LEFT BLANK



ROYAL CANADIAN AIR CADETS
PROFICIENCY LEVEL FOUR
INSTRUCTIONAL GUIDE



SECTION 3

EO C470.03 – IDENTIFY AVIATION HARDWARE

Total Time:

30 min

PREPARATION

PRE-LESSON INSTRUCTIONS

Resources needed for the delivery of this lesson are listed in the lesson specification located in A-CR-CCP-804/PG-001, *Proficiency Level Four Qualification Standard and Plan*, Chapter 4. Specific uses for said resources are identified throughout the instructional guide within the TP for which they are required.

Review the lesson content and become familiar with the material prior to delivering the lesson.

The activity in TP 1 uses learning stations. Learning stations are a form of group work, where the cadets learn by sorting through the information presented. When setting up learning stations, ensure there is enough room for each cadet to be comfortable and adequate space for writing down information. When the cadets arrive at a learning station, all required information shall be available. These stations should be placed closely together to minimize time for movement; however, far enough apart to avoid interruptions from other groups. For this lesson, set up four learning stations for aviation hardware.

Photocopy the Aviation Hardware Handout located at Attachment A (one per cadet), Aviation Hardware Information Sheets located at Attachments B–E (one attachment per station), and the Aviation Hardware Identification Worksheet located at Attachment F (one per cadet).

PRE-LESSON ASSIGNMENT

Nil.

APPROACH

An in-class activity was chosen for this lesson as it is an interactive way to provoke thought and stimulate interest among cadets.

INTRODUCTION

REVIEW

Nil.

OBJECTIVES

By the end of this lesson the cadet shall have identified aviation hardware.

IMPORTANCE

It is important for cadets to be able to identify aviation hardware as each type of hardware has a specific application. Using the correct type of aviation hardware during maintenance activities and the manufacturing of aircraft and aircraft components ensures that the design specifications and safety tolerances are maintained. Using the incorrect type of aviation hardware could jeopardize the safety of the aircrew, passengers, and personnel on the ground.

Teaching Point 1**Conduct an activity where the cadets will identify aviation hardware.**

Time: 25 min

Method: In-Class Activity

ACTIVITY**OBJECTIVE**

The objective of this activity is to have the cadets identify aviation hardware.

RESOURCES

- Pen / pencil,
- Aviation Hardware Handout located at Attachment A,
- Aviation Hardware Information Sheets located at Attachments B–E,
- Aviation Hardware Identification Worksheet located at Attachment F, and
- Aviation Hardware Identification Worksheet Answer Key located at Attachment G.

ACTIVITY LAYOUT

If samples of aviation hardware are available, place them at the appropriate learning station.

ACTIVITY INSTRUCTIONS

1. Brief cadets on activity instructions, to include:
 - a. time limit for each station (five minutes),
 - b. direction of rotation between stations,
 - c. signal for rotation,
 - d. explanation of Aviation Hardware Information Sheets, and
 - e. an overview of the Aviation Hardware Identification Worksheet.
2. Distribute the Aviation Hardware Identification Worksheet located at Attachment F (to each cadet).
3. Divide the cadets into four groups and assign a number to each group.
4. Have groups move to the learning station which corresponds to their group number.
5. Have the cadets complete the Aviation Hardware Identification Worksheet while rotating from station to station every five minutes.



It is important to circulate around the room to facilitate the activities and help the cadets as required. If possible, assign other instructors to aid with the supervision and facilitation.

6. Once each group has been to each station, have one cadet from each group share the information they recorded from the station they just completed with the rest of the cadets. In most cases, the groups will have recorded the same information for each station. If a group has listed different information, have them share their answers.

SAFETY

Nil.

CONFIRMATION OF TEACHING POINT 1

The cadets' participation in the activity will serve as the confirmation of this TP.

END OF LESSON CONFIRMATION

The cadets' completion of the Aviation Hardware Identification Worksheet will serve as the confirmation of this lesson.

CONCLUSION

HOMEWORK / READING / PRACTICE

Nil.

METHOD OF EVALUATION

Nil.

CLOSING STATEMENT

Aviation hardware comes in a variety of types, each with a specific application. Using the correct type of aviation hardware during the manufacture and maintenance of aircraft and aircraft components is important to ensure that the safety of the aircrew, passengers, and personnel on the ground is not compromised.

INSTRUCTOR NOTES / REMARKS

Cadets who are qualified Advanced Aviation Technology – Aircraft Manufacturing and Maintenance may be able to assist with this lesson.

REFERENCES

C3-136 ISBN 0-88487-207-6 Sanderson Training Systems. (2001). *A&P technician airframe textbook*. Englewood, CO: Jeppesen Sanderson Inc.

C3-137 ISBN 0-88487-203-3 Sanderson Training Systems. (2000). *A&P technician general textbook*. Englewood, CO: Jeppesen Sanderson Inc.

Aviation Hardware Handout

Aviation hardware refers to the different types of fasteners and small items used during the manufacture and maintenance of aircraft and aircraft components. Although many of these items are small in size, their importance is large.

With more than 30 000 different fasteners available for aviation applications, it is important to be able to identify the different types of aviation hardware as their correct use is paramount for the safe and efficient operation of aircraft.

Aviation hardware comes in a variety of shapes and sizes, as well as in a variety of materials. Over the years, there have been many different ways to standardize the description of aviation hardware.

AMS (Aeronautical Material Specifications)	AN (Air Force–Navy)
AND (Air Force–Navy Design)	AS (Aeronautical Standard)
ASA (American Standards Association)	ASTM (American Society for Testing and Materials)
MS (Military Standard)	NAF (Naval Aircraft Factory)
NAS (National Aerospace Standard)	SAE (Society of Automotive Engineers)

Figure A-1 Aviation Hardware Specifications and Standards Codes

Note. From *A&P Technician General Textbook* (p. 8-2), by Jeppesen Standard Training Products, 2000, Englewood, CO: Jeppesen Sanderson Training Systems.

The two most common specification and standard identification systems used in aviation today are the Air Force–Navy (AN) and Military Standards 20 (MS20) systems. Both systems use a similar coding method to describe the physical characteristics of aviation hardware (eg, rivets, bolts, nuts, etc). An example of this is shown in Figure A-2. While there are minor differences between different systems, the same piece of hardware can be described by different systems (eg, an AN365 self-locking nut is the same as a MS20365 self-locking nut).

Rivet Designation	Physical Characteristics	
AN470-AD4-5	AN	Specification and standard (Air Force–Navy system)
	470	Head style (universal head)
	AD	Material code (2117 aluminum alloy)
	4	Diameter (4/32 inch)
	5	Length (5/16 inch)

Figure A-2 Rivet Specification Decoded

Note. Created by Director Cadets 3, 2009, Ottawa, ON: Department of National Defence.

Although there are many different types of fasteners used in aviation, there are five main categories:

- bolts (includes washers and nuts),
- rivets,
- special fasteners,

- machine screws, and
- turnlock fasteners.

Each category has its own unique terminology, although some terms may have similar meanings, as well as special tools and procedures for installation and removal.

Fasteners are used in two distinct applications in aviation: structural and non-structural. When used as a structural fastener, it is especially important that the correct hardware is used as the hardware forms part of the structure of the aircraft and is expected to be able to carry a specific load without failing.

Examples of structural fasteners include:

- bolts connecting the wing spar to the fuselage,
- rivets connecting the wing skin to the wing ribs, and
- bolts connecting the landing gear to the fuselage.

Examples of non-structural fasteners include:

- turnlock fasteners on inspection covers and cowlings,
- machine screws on interior panels, and
- bolts holding instruments in place in the instrument panel.

Aircraft plans, parts manuals, and repair manuals all include very specific details on the exact type of aviation hardware to be used. Builders and maintenance personnel must not substitute alternate hardware without ensuring that design specifications are not compromised.

When compared to standard or automotive hardware, aviation hardware is manufactured to higher standards, generally has a higher strength rating, and may come with a variety of finish or coating option. While non-aviation hardware may be legal for use on home-built aircraft, most associations strongly recommend the use of aviation hardware.

BOLTS

A bolt is designed to hold two or more items together. Bolts come in a variety of sizes, shapes, materials and strengths so that the correct fastener can be used for each application. Bolts are used for both structural and non-structural applications.

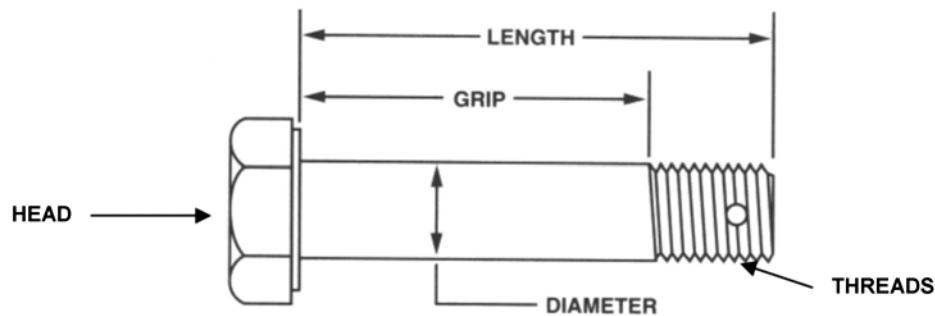

Figure B-1 AN (Airforce Navy) Bolt Dimensions

Note. From *A&P Technician General Textbook* (p. 8-17), by Jeppesen Standard Training Products, 2000, Englewood, CO:Jeppesen Sanderson Training Systems.

Standard AN Bolt Classification

Standard bolts classified using the AN system, are classified using the diameter and length, and additional modifiers (eg, material, drilled holes) are added. Diameters are indicated in 1/16-inch increments and length in 1/8-inch increments.

For example, an AN4-7 bolt has a diameter of 4/16 inch (1/4 inch) and a length of 7/8 inch. The length of the bolt is also known as the dash number. Dash numbers of eight and nine (-8 and -9) are not used. This means that a bolt length of 1 inch is represented with -10 (2 inches is -20, 3 inches is -30). For example, an AN5-22 bolt has a diameter of 5/16 inch and is 2-2/8 inches long (2-1/4 inches).

The material used for the bolt is indicated by replacing the dash with letters to indicate the material (the dash indicates that the bolt is made of cadmium-plated nickel steel). A corrosion-resistant bolt is represented with the letter C. Aluminum alloy bolts use the letters DD.

Standard bolts have a hole drilled in the threaded portion for a cotter pin (to keep the nut from coming off). To indicate a bolt without a hole, the letter A is added to the end of the bolt number (eg, AN5-22A). To indicate a bolt that has a hole drilled in the head (for locking wire), the letter H is inserted after the diameter (eg, AN6H34).

Threads

Threads are classified by the number of threads per inch (the number of times the threads rotate [number of turns] around a 1-inch length of a given diameter bolt or screw). Different standards for threads are American National Coarse (NC), American National Fine (NF), American Standard Unified Coarse (UNC), and American Standard Unified Fine (UNF).

Threads are also designated by the class of fit (from one to five). A Class 1 thread is a loose fit (the nut may be turned all the way from start to finish with just your fingers). A Class 5 thread is a tight fit (the nut requires a wrench from start to finish). Most aviation bolts are fine threaded with a Class 3 fit.

Nuts and Washers

Nuts are threaded onto the end of the bolt to prevent it from coming out. In some applications, the nut may also carry a load. Due to the vibrations experienced in a typical aircraft, most nuts must be locked onto the bolts. To keep the nut from coming loose, a cotter pin can be inserted through the hole in the bolt (a castle nut is used in this type of application) or a lock nut (nylon or metal) is used.

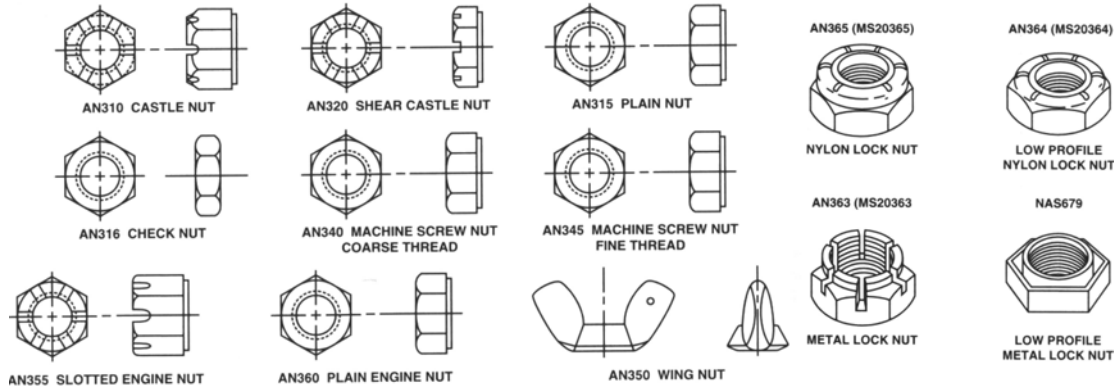

Figure B-2 Standard Aircraft Nuts

Note. From *A&P Technician General Textbook* (p. 8-21), by Jeppesen Standard Training Products, 2000, Englewood, CO:Jeppesen Sanderson Training Systems.

Washers are used to ensure that the bolt fits properly, to prevent the nut and / or bolt head from damaging the parts, and in the case of lock washers, to help prevent the nut from coming loose.

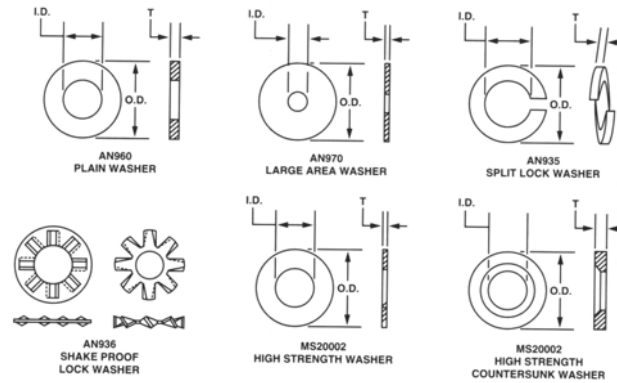

Figure B-3 Aircraft Washers

Note. From *A&P Technician General Textbook* (p. 8-30), by Jeppesen Standard Training Products, 2000, Englewood, CO:Jeppesen Sanderson Training Systems.

RIVETS

Rivets are used to join metal parts together, especially sheet metal parts (eg, attaching the metal skin of the wing to the metal ribs in the wing). When installed properly, rivets create a joint at least as strong as the material being joined.

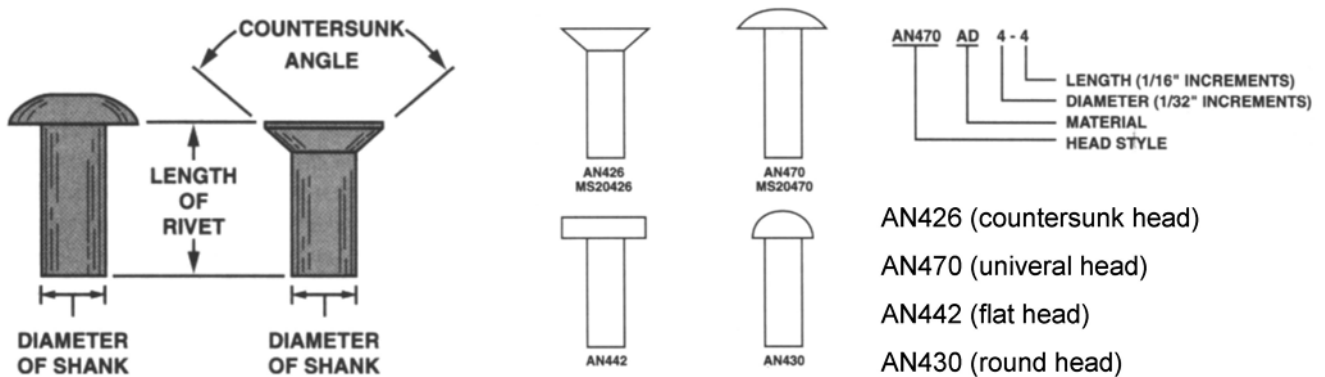

Figure C-1 Dimensions and AN Designations

Note. From *A&P Technician Airframe Textbook* (p. 2-36), by Jeppesen Standard Training Products, 2000, Englewood, CO: Jeppesen Sanderson Training Systems.

The general process for installing a rivet is to drill a hole slightly larger than the initial diameter of the rivet in the two pieces being joined. The rivet is inserted into the hole, and both ends of the rivet are carefully pressed together using special tools (a rivet gun on the head, and a bucking bar on the opposite end). The shank of the rivet swells to fill the hole, and the end of the rivet flattens out.

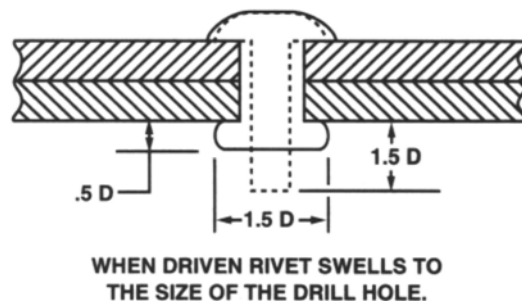

Figure C-2 Before and After Driving a Rivet

Note. From *A&P Technician Airframe Textbook* (p. 2-36), by Jeppesen Standard Training Products, 2000, Englewood, CO: Jeppesen Sanderson Training Systems.

Special Rivets

Standard rivets require access to both ends of the rivet to properly install it. Special rivets that only require access to one end have been developed for use in areas of the aircraft where it is not possible to access both ends of the rivet. These special rivets are also known as blind rivets and come in a variety of styles, usually identified by a brand name (eg, Huck-Lok, CherryLOCK, CherryMAX, Olympic-Lok).

Pop Rivets

Pop rivets are a type of special rivet (blind rivet). Although very common in non-aviation applications, pop rivets have limited uses in aviation. They are never used for structural applications, except as a temporary way to line up parts while installing permanent rivets.

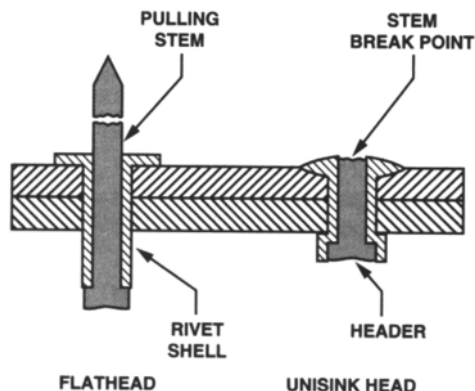

Figure C-3 Pop Rivets

Note. From *A&P Technician Airframe Textbook* (p. 2-40), by Jeppesen Standard Training Products, 2000, Englewood, CO:Jeppesen Sanderson Training Systems.

Cleco Fasteners

Prior to installing rivets, the parts need to be properly aligned and held in place. The most common method for doing this is by clamping the parts together. One of the most common clamping devices used in aviation is the Cleco fastener. A Cleco fastener is basically just a removable rivet.



Figure C-4 Cleco Pliers and Cleco Fasteners

Note. From "Cleco Pliers, Cleco Tool for Cleco Fasteners", *William Lees Sons Ltd.* Retrieved March 24, 2009, from <http://www.skinpins.com/toolsC200pliers.html>

A Cleco fastener is inserted into a hole (that will eventually hold a rivet) using a special pair of pliers and clamps the metal pieces together. Once the pieces are properly aligned (usually with a Cleco fastener in each rivet hole) the Cleco fasteners are removed one at a time and replaced by the permanent rivet.

Cleco fasteners come in different sizes that correspond to common rivet sizes. Each size is colour coded for easy identification.

Rivet / Cleco Diameter	Rivet Diameter Dash Number	Colour
3/32 inch	-3	Silver
1/8 inch	-4	Copper
5/32 inch	-5	Black
3/16 inch	-6	Brass
1/4 inch	-8	Copper

Figure C-5 Cleco Fastener Diameters and Colours

Note. From *A&P Technician Airframe Textbook* (p. 2-34), by Jeppesen Standard Training Products, 2000, Englewood, CO: Jeppesen Sanderson Training Systems.

THIS PAGE INTENTIONALLY LEFT BLANK

SCREWS

Screws are a very common threaded fastener in aviation and there are three basic classifications: machine screws, structural screws, and self-tapping screws. Screws generally have a loose fitting thread (eg, Class 2) and may have either a clearly defined grip length that is partially threaded or be threaded along their entire length. While most screws have heads designed to accept a screwdriver, some have heads that require a wrench.

Machine Screws

Machine screws are generally used for attaching fairings, inspection plates, fluid line clamps, and other light structural parts. Machine screws are usually threaded along their entire length and are available with national coarse or national fine threads. These screws may be made of several different types of materials and may be coated or treated in various ways.

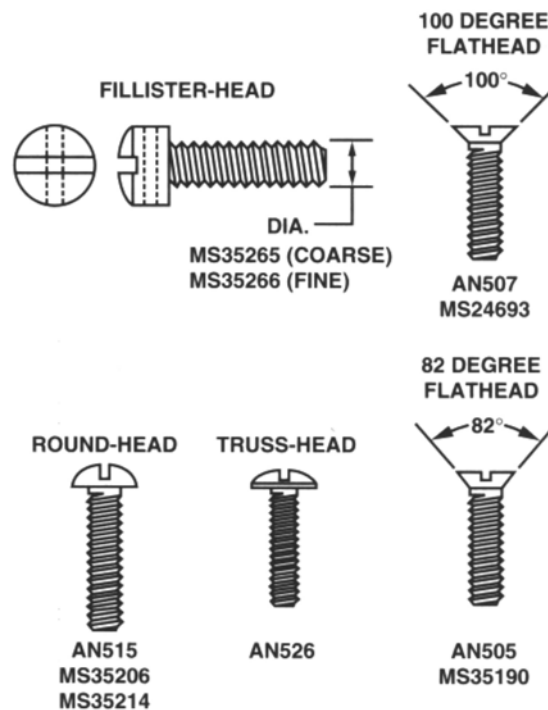

Figure D-1 Machine Screws

Note. From *A&P Technician General Textbook* (p. 8-27), by Jeppesen Standard Training Products, 2000, Englewood, CO:Jeppesen Sanderson Training Systems.

Structural Screws

Structural screws are very similar to standard bolts. They are heat treated and have the same shear strength as a bolt of the same size. Shank tolerances are similar to bolts and the threads are national fine.

Self-Tapping Screws

Self-tapping screws are used to hold thin sheets of metal, plastic, or plywood together. They have a coarse thread and come with a sharp (Type A) or blunt (Type B) point.

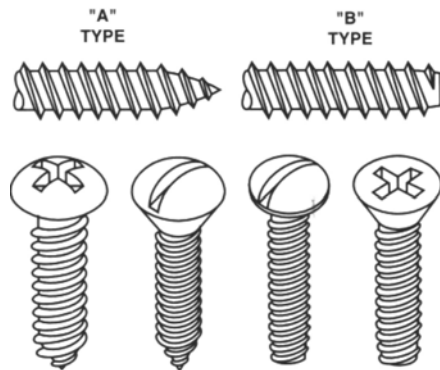

Figure D-2 Self-Tapping Sheet Metal Screws

Note. From *A&P Technician General Textbook* (p. 8-28), by Jeppesen Standard Training Products, 2000, Englewood, CO:Jeppesen Sanderson Training Systems.

TURNLOCK FASTENERS

Turnlock fasteners are used when quick and easy removal or opening of access panels, doors, and cowlings is required. There are three common types, each identified by their trade or brand name: Dzus, Airloc, and Camlock.

Dzus Fastener

Dzus (pronounced Zeus) fasteners are commonly found on cowling and inspection panels that must be frequently opened. The stud is mounted on the cowling or panel, and fits into the receptacle when the parts are aligned (closed). A quarter turn of the stud opens or closes the fastener. When closed, the stud grips a spring in the receptacle which keeps it closed.

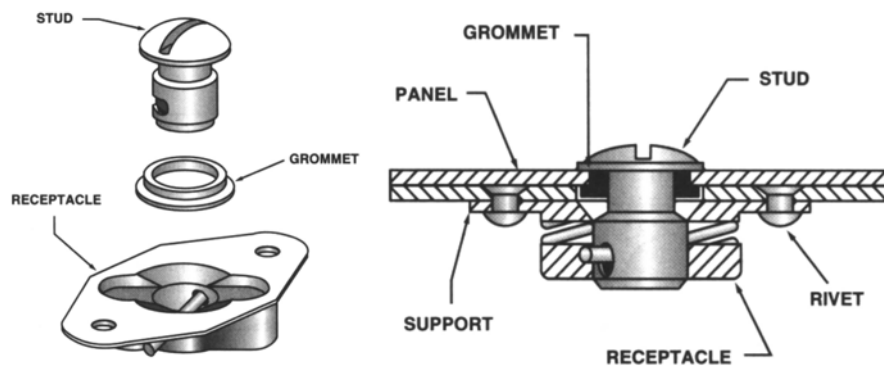

Figure E-1 Dzus® Fastener

Note. From *A&P Technician Airframe Textbook* (p. 2-49), by Jeppesen Standard Training Products, 2000, Englewood, CO:Jeppesen Sanderson Training Systems.

Airloc Fasteners

Airloc fasteners use a stud that has a pin, as opposed to Dzus fasteners that have a notch in the pin. When turned, the pin engages the spring in the receptacle. These fasteners are used in the same applications as Dzus fasteners.

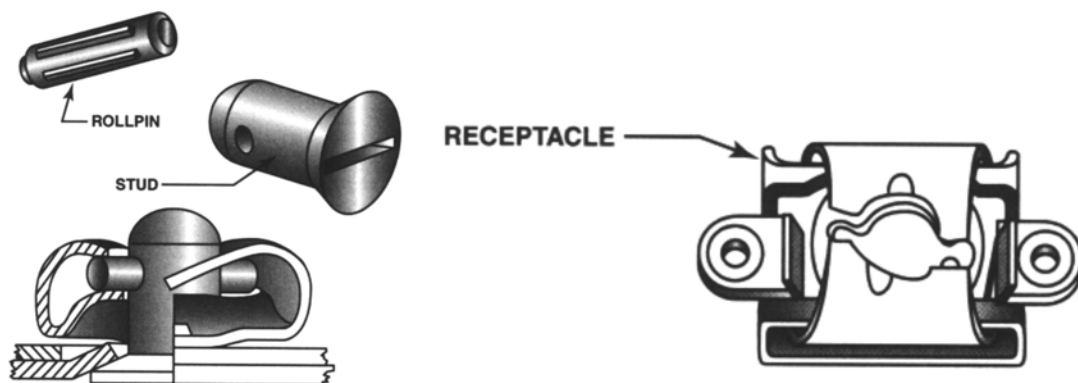

Figure E-2 Airloc® Cowling Fastener

Note. From *A&P Technician Airframe Textbook* (p. 2-50), by Jeppesen Standard Training Products, 2000, Englewood, CO:Jeppesen Sanderson Training Systems.

Camlock Fasteners

Camlock fasteners have a stud assembly that includes a spring and a pin. When the stud is pressed into the receptacle, the spring compresses and allows the pin to be rotated into position in the receptacle. When the stud is released, the spring expands, and holds the pin in place in a groove in the bottom of the receptacle.

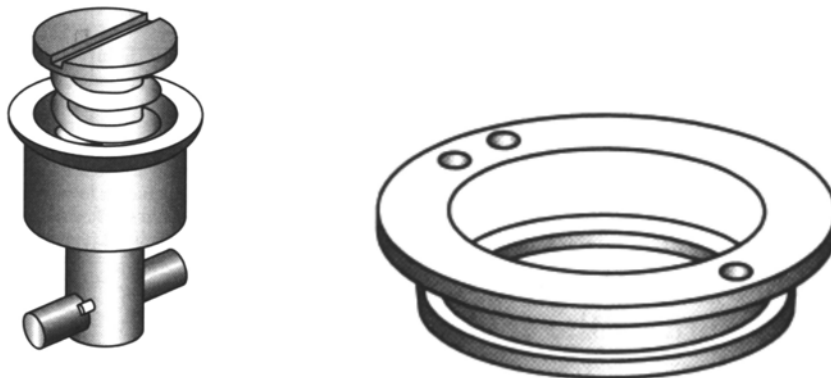

Figure E-3 Camlock® Cowling Fastener

Note. From *A&P Technician Airframe Textbook* (p. 2-50), by Jeppesen Standard Training Products, 2000, Englewood, CO:Jeppesen Sanderson Training Systems.

Aviation Hardware Identification Worksheet

Aviation Hardware

What two specification and standard identification systems are the most common?

_____, and
_____.

Bolts

Identify the aviation hardware shown below:



An AN7-12 bolt:

- has a length of _____ inch(es),
- has a diameter of _____ inch(es),
- is made of _____, and
- _____ a hole drilled in the head for lock wire.

An AN3-13A bolt:

- has a length of _____ inch(es),
- has a diameter of _____ inch(es),
- is made of _____, and
- _____ a hole drilled in the threads for a cotter pin.

Rivets

Identify the aviation hardware shown below:



An AN442AD4-4 rivet:

- has a length of _____ inch(es),
- has a diameter of _____ inch(es), and
- has a _____ head.

Pop rivets _____ used for structural applications.

_____ are used when there is not easy access to both ends of the rivet.

Screws

Identify the aviation hardware shown below:

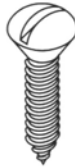

Most screws are installed using a _____. Some screws may require a _____ to install them.

Turnlock Fasteners

Identify the aviation hardware shown below:

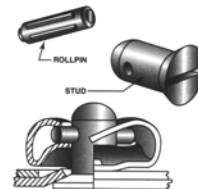
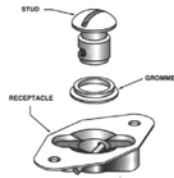
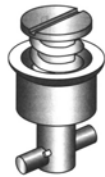

Most turnlock fasteners only need to be turned _____ to be opened or closed.

Aviation Hardware Identification Worksheet Answer Key

Aviation Hardware

What two specification and standard identification systems are the most common?

 AIR FORCE-NAVY (AN) , and

 MILITARY STANDARDS 20 (MS20) .

Bolts

Identify the aviation hardware shown below:



 AIRCRAFT BOLTS



 NYLON LOCK NUT



 PLAIN WASHER (AN690)

An AN7-12 bolt:

- has a length of 1-1/4 inch(es),
- has a diameter of 7/16 inch(es),
- is made of CADMIUM-PLATED NICKEL STEEL , and
- DOES NOT HAVE a hole drilled in the head for lock wire

An AN3-13A bolt:

- has a length of 1-3/8 inch(es),
- has a diameter of 3/16 inch(es),
- is made of CADMIUM-PLATED NICKEL STEEL , and
- DOES NOT HAVE a hole drilled in the threads for a cotter pin.

Rivets

Identify the aviation hardware shown below:



 ROUND HEAD RIVET
(AN430)



 CLECO FASTENER

An AN442AD4-4 rivet:

- has a length of 1/4 inch(es),
- has a diameter of 1/8 inch(es), and
- has a FLAT head.

Pop rivets ARE NOT used for structural applications.

SPECIAL (BLIND) RIVETS are used when there is not easy access to both ends of the rivet.

Screws

Identify the aviation hardware shown below:



MACHINE SCREW

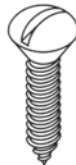

SELF-TAPPING SCREW

Most screws are installed using a SCREWDRIVER. Some screws may require a WRENCH to install them.

Turnlock Fasteners

Identify the aviation hardware shown below:

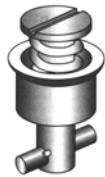

DZUS FASTENER

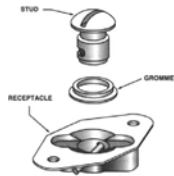

CAMLOCK FASTENER

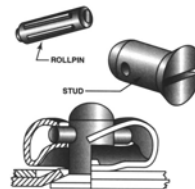

AIRLOC FASTENER

Most turnlock fasteners only need to be turned ONE QUARTER OF A TURN to be opened or closed.